

TRANSDUCTION



USER'S MANUAL

Version 1.0

07/30/08

TR-9200 1U 19" RACK MOUNT KEYBOARD
MOUSE MONITOR

TR-9300 1U 19" RACK MOUNT KVM SWITCH

5155-23 Spectrum Way, Mississauga, ON Canada L4W 5A1

TEL: 1-800-268-0427, 905-625-1907

FAX: 905-625-0531

Email: sales@transduction.com

PACKING LIST

The complete TR-9200 package consists of:

- ◆ 1 x 1U 19" rack mount console: the TR-9200
- ◆ Rear mounting kit
 - 2 x short L-shaped brackets
 - 2 x long L-shaped brackets
 - 2 x expanding brackets
 - 2 x supporting brackets
- ◆ 1 x VGA cable and 1 x DVI cable
- ◆ 1 x power cord
- ◆ 2 x identical keys of the lock

The complete TR-9300 package consists of:

- ◆ 1 x 1U 19" rack mount console: the TR-9300
- ◆ Rear mounting kit
 - 2 x short L-shaped brackets
 - 2 x long L-shaped brackets
 - 2 x expanding brackets
 - 2 x supporting brackets
- ◆ 1 x 1.8m KVM cable(3 in 1 cable, PS/2 mouse, PS/2 keyboard, DB15 VGA)
- ◆ 1 x power cord
- ◆ 2 x identical keys of the lock

Check to make sure that the unit is not damaged in shipping. If you encounter a problem, contact your local dealer for service.

Please read this manual thoroughly, and follow the installation and operation procedures carefully to prevent any damage to the TR-9200/9300, and/or any of the devices that connect to it.

SAFETY INSTRUCTIONS

1. Please read these safety instructions carefully.
2. Please keep this User's Manual for later reference.
3. Please disconnect this equipment from power source before cleaning. Don't use liquid or sprayed detergent for cleaning. Use moisture sheet or clothe for cleaning.
4. For pluggable equipment, the socked-outlet shall be installed near the equipment and shall be easily accessible.
5. Please keep this equipment from humidity.
6. Lay this equipment on a reliable surface when install. A drop or fall could cause user injured.
7. Do not leave this equipment in an environment unconditioned, storage temperature above 60^o C, it may damage the equipment.
8. The opening on the enclosure are for air convection protecting the equipment from overheating. **DO NOT COVER THE OPENING.**
9. Make sure to apply proper input power voltage to the equipment.
10. Please shield the power cord in the way that people can not step on it. Do not place anything over power cord. The power cord must rated fro the voltage and current marked on the product's electrical ratings labell. The voltage and current ratings of the cord should match the voltage and the current rating marked on the product.
11. All cautions and warnings on the equipment should be noted.
12. If the equipment is not in use for a long time, disconnect the equipment from mains to avoid being damaged by transient voltage surge.
13. Never pour liquid into ventilation openings, this could cause fire or electrical shock.
14. Never open the equipment. For safety reason, only qualified service technicians are allowed to open the equipment.
15. If one of the following situations arises, get the equipment checked by service technicians .
 - ◆ The Power Cord or plug is damaged.
 - ◆ Liquid has leaked inside the equipment.
 - ◆ The equipment has been exposed to moisture.
 - ◆ The equipment has not worked well or you can not get it to work according to User's Manual.
 - ◆ The equipment has dropped and damaged.
 - ◆ The equipment has obvious signs or breakage.

TABLE OF CONTENTS

PACKING LIST	1
SAFETY INSTRUCTIONS	2
TABLE OF CONTENTS	3
CHAPTER 1 GENERAL INFORMATION	4
1.1 Overview.....	4
1.2 Product Specification.....	5
1.3 Hardware Requirement	7
1.4 Mounting the unit to your cabinet	8
1.4.1 Mounting the TR-9200/9300 into 750 mm cabinets	9
1.4.2 Mounting the TR-9200/9300 into 900 mm cabinets	10
CHAPTER 2 17” TFT LCD PANEL	11
2.1 Introduction.....	11
2.1.1 Specifications.....	11
2.1.2 Factory Preset Timing for Reference.....	12
2.2 Panel Controls and OSD Functions	13
2.2.1 Auto tuning.....	13
2.2.2 Input signal (TR-9200 only).....	13
2.2.3 Brightness/contrast.....	13
2.2.4 Color	14
2.2.5 Image quality	14
2.2.6 Miscellaneous settings.....	15
2.2.7 Power Indicator.....	15
CHAPTER 3 INSTALLATION	16
3.1 Installing the Video Card and Video Driver	16
3.1.1 Configuring the Display Settings	16
3.2 Connecting the Drawer	16
3.3 Turning On the Drawer.....	17
3.4 Testing the Drawer.....	17
CHAPTER 4 KVM Switch (TR-9300 only)	18
4.1 Features	18
4.2 Installation of TR-9300	18
4.2.1 Before You Begin.....	18
4.2.2 Single Station Installation.....	18
4.2.3 Two Station & Three Installation	19
4.2.4 Front View	19
4.3 Hot Plugging	20
4.3.1 Powering Off and Restarting	20
4.3.2 Port Selection	20
4.4 Port ID Numbering	21
4.4.1 Overview	21
4.4.2 Port Key In Examples:	21
4.4.3 Hotkey Summary Table	21
4.5 OSD Operation.....	21
4.5.1 Overview	21
4.5.2 OSD Navigation	22
4.5.3 Hotkey Navigation	22
4.5.4 OSD Main Menu Headings:.....	23
4.5.5 The Function Keys:	23
4.5.6 Factory Default Settings.....	27
4.5.7 OSD Security	27
4.6 Trouble Shooting.....	28

CHAPTER 1 GENERAL INFORMATION

1.1 Overview

The TR-9200/9300 is an ideal solution for network administration with multiple servers / platforms. Their 17-inch large size TFT LCD color display and ultra-low-profile compact industrial keyboard / trackball provide the user-friendliest and most reliable environment for network administrators. All these functions are integrated in a 19-inch 1U space with rugged construction design to achieve ultra space saving and high reliability for high quality industrial/network applications.

The built-in KVM switch of the TR-9300 enables easy accessibility to 8 servers / platforms and supports PS/2 keyboard, PS/2 mouse, and DB15 VGA with eight DB25 connectors. By cascading function, it can connect up to 512 computers or servers.

The TR-9200/9300 monitor / keyboard drawers provide superior picture quality and state-of-the-art features mounted in an industrial grade, rack mount drawer. The drawer forms a rugged enclosure that protects the monitor from industrial hazards and permits easy access to monitor controls.

The TR-9200/9300 monitors provide flicker-free color images at optimal resolutions.

The

monitors' 0.264mm pixel pitch ensures crisp images with clear definition, even at high resolutions. The TR-9200/9300 monitors are intelligent, microprocessor-based, and have an ergonomically designed display.

The TR-9200/9300 monitors employ the latest in active matrix thin film transistor (TFT) technology, providing crisp screen images and wide viewing angles. Unlike CRT monitors, LCD monitors are inherently immune to the magnetic fields commonly found on the plant floor or communications centers. LCDs are also typically brighter than conventional CRT technology, making them ideal for the high ambient lighting conditions found in many of today's factory environments. On-screen menus allow for display adjustments. In addition, the monitors' Plug-n-Play+ features support Windows 95/98 and NT, while a universal power supply ensures global applicability.

The TR-9200/9300 monitors are compatible with most analog RGB (red, green, blue) display standards, including PS/V, PS/2, optional for Apple Macintosh Centris, Quadra, and Macintosh II family signals. The LCD monitor is capable of displaying crisp and vibrant color graphics with VGA, SVGA, XGA (non-interlaced), and most Macintosh compatible color video cards.

1.2 Product Specification

Product Specification	
Standard	Meets EIA RS-310C 1U 19" rack mount standard
Dimension (H x W x D)	43 x 443 x 548 (mm)
LCD Panel	17" Active -Matrix TFT LCD
Anti-reflection Glass for LCD	2 x 351 x 284 (mm)
Maximum Resolution	1280 x 1024 pixels
Input signal format	DVI (TR-9200 only) or RGB Analog Video
Display control	All graphic user's interface on-screen-display control
Keyboard	PS/2 84-key slim keyboard
Mouse	PS/2 high-quality trackball with two mouse buttons
Gross Weight	14 Kg
Certification	FCC class A, CE

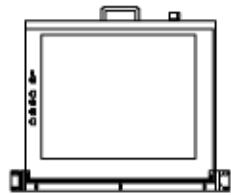
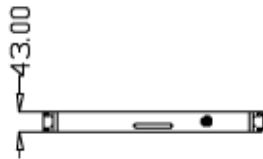
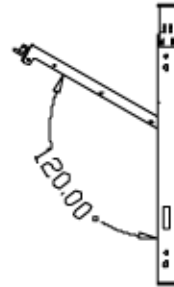
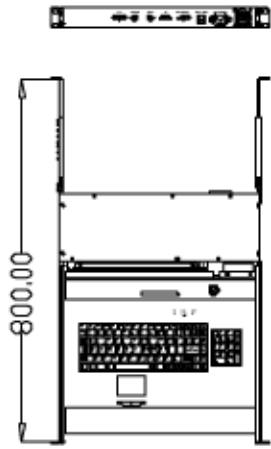
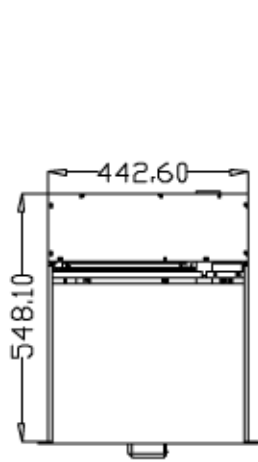

The TR-9200

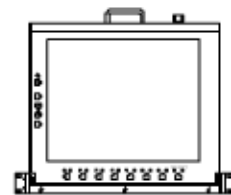
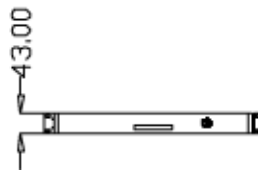
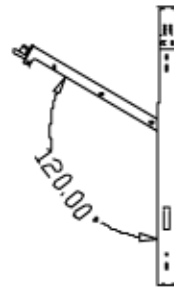
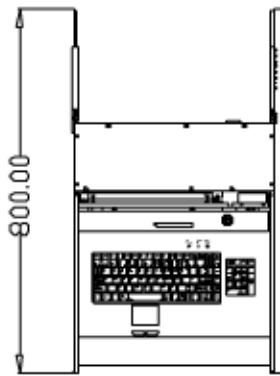
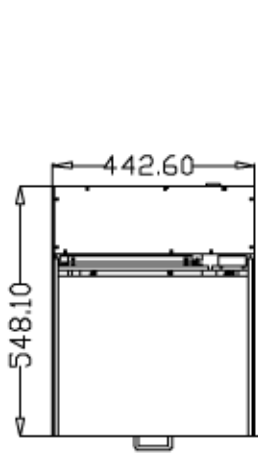

The TR-9300

1.3 Hardware Requirement

Computers

Your PC must have a VGA, SVGA, or Multisync video card and video driver already installed for the monitor. If you need to install a video card or a video driver, refer to your computer documentation for instructions.

- ◆ Your Macintosh will require a “mac adapter” for video.
- ◆ Your Sun server will require a DVI video output and USB keyboard/mouse inputs (for TR-9200 only)
- ◆ Your PC-compatible computer must have a 6-pin mini-DIN (PS/2 style) mouse port
- ◆ Your PC-compatible computer must have a 6-pin mini-DIN (PS/2 Style) keyboard port.

KVM Cables

For optimum signal integrity and to simplify the layout, we strongly recommend that you use the following high quality custom cable sets:

PS/2 (6 pin mini-DIN) Keyboard and Mouse, VGA (15 pin D-sub)	2L-1601P, 2L-1603P, 2L-1605P, 2L-1610P
Daisy Chain TR-9300 and other KVM switches	2L-1601P, 2L-1603P, 2L-1605P, 2L-1610P

1.4 Mounting the unit to your cabinet

The unit is designed for standard 750mm and 900mm cabinets*. You may find the rear mounting kit in the carton.

Please use the following combination to fit in different cabinets.



For 750mm cabinets

Short L-bracket x 2

Extended bracket x 0 (not necessary)

Supporting bracket x 2



For 900mm / 850mm

cabinets Long L-bracket x 2

Extended bracket x 2

Supporting bracket x 2 (the same as those for 750mm cabinets)

1.4.1 Mounting the TR-9200/9300 into 900/850 mm cabinets



1. Fasten the supporting brackets with the chassis.



2. Fasten the extended brackets with the supporting brackets.

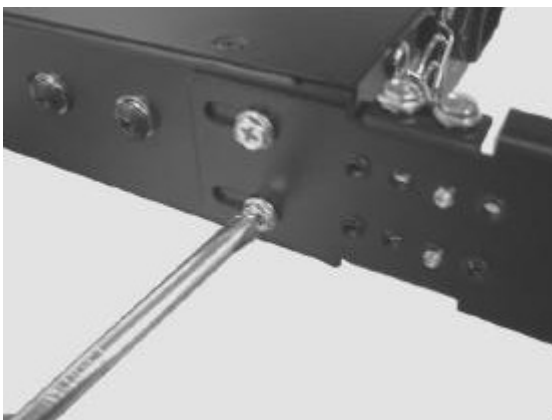

3. Screw the extended brackets with the system chassis.



4. Mount the L-brackets into the guide of the extended brackets, and fasten them with the cabinet loosely. Adjust the system alignment, and fasten the screws.

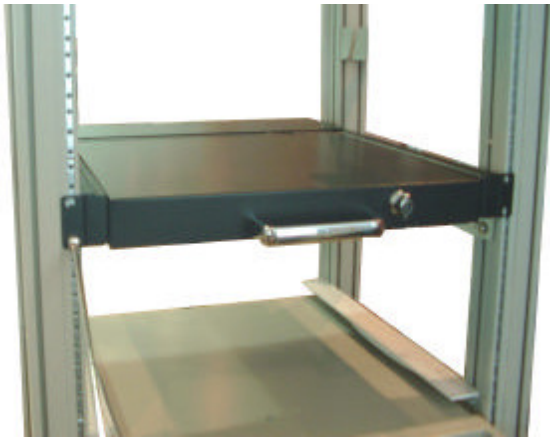

5. Fasten the front screws and the rear ones.

1.4.2 Mounting the TR-9200/9300 into 750 mm cabinets

Follow the same procedure as mounting the TR-9200/9300 into the 900 mm cabinet, but the extended brackets would be unnecessary.

CHAPTER 2 17" TFT LCD PANEL

2.1 Introduction

2.1.1 Specifications

Specification		
LCD	Screen Type	TFT LCD
	Display Area	337.920mm(H) x 270.336mm(V)
	Contrast Ratio (CR)	400:1 typical
	Viewing Angle	Up/down:140/160 degrees (CR=10/5) Left/right:140/160 degrees (CR=10/5)
	Number of pixels	1280 x 1024
	Pixel pitch (H x W)	0.264mm x 0.264mm
	Response Time	16 msec (rising/ falling: 12/4 msec)
	Brightness	260cd/m2
	Panel Color	262 K
	Back Light	4 Lamps
	Power Management	
Plug & Play		DDC1 & DDC2B
Power Supply	Power Consumption	45 watts (typical)
	Power saving	VESA DPMS Standard, EPA/Energy Star compliant
Regulations		FCC class A, CE, UL (certification is pending up to the time this pilot run manual is written)

2.1.2 Factory Preset Timing for Reference



Type	Resolution	Remark
Analog	VESA 640*350@ 70Hz	TR-9200/TR-9300
Analog	VESA 640*400@ 70Hz	TR-9200/TR-9300
Analog	VESA 720*400@ 70Hz	TR-9200/TR-9300
Analog	VESA 640*480@ 60Hz	TR-9200/TR-9300
Analog	VESA 640*480@ 72Hz	TR-9200/TR-9300
Analog	VESA 640*480@ 75Hz	TR-9200/TR-9300
Analog	VESA 800*600@ 56Hz	TR-9200/TR-9300
Analog	VESA 800*600@ 60Hz	TR-9200/TR-9300
Analog	VESA 800*600@ 72Hz	TR-9200/TR-9300
Analog	VESA 800*600@ 75Hz	TR-9200/TR-9300
Analog	Mac II 35K 66.67Hz	TR-9200/TR-9300
Analog	VESA 1024*768@ 60Hz	TR-9200/TR-9300
Analog	VESA 1024*768@ 70Hz	TR-9200/TR-9300
Analog	VESA 1024*768@ 75Hz	TR-9200/TR-9300
Analog	MAC II-832*624@ 74.91Hz	TR-9200/TR-9300
Analog	VESA 1024*768@ 72Hz	TR-9200/TR-9300
Analog	VESA 1280*1024@ 60Hz	TR-9200/TR-9300
Analog	Compaq1024*768@ 66Hz	TR-9200/TR-9300
Analog	VESA 1280*1024@ 75Hz	TR-9200/TR-9300
Analog	VESA 1280*1024@ 70Hz	TR-9200/TR-9300
Digital	DVI 640*350@ 70Hz	TR-9200 only
Digital	DVI 640*400@ 70Hz	TR-9200 only
Digital	DVI 720*400@ 70Hz	TR-9200 only
Digital	DVI 640*480@ 60Hz	TR-9200 only
Digital	DVI 640*480@ 72Hz	TR-9200 only
Digital	DVI 640*480@ 75Hz	TR-9200 only
Digital	DVI 800*600@ 56Hz	TR-9200 only
Digital	DVI 800*600@ 60Hz	TR-9200 only
Digital	DVI 800*600@ 72Hz	TR-9200 only
Digital	DVI 800*600@ 75Hz	TR-9200 only
Digital	DVI mac-II@ 66.67Hz	TR-9200 only
Digital	DVI 1024*768@ 60Hz	TR-9200 only
Digital	DVI 1024*768@ 70Hz	TR-9200 only
Digital	DVI 1024*768@ 75Hz	TR-9200 only
Digital	DVI ma cII-832*624@ 74.9Hz	TR-9200 only
Digital	DVI 1024*768@ 72Hz	TR-9200 only
Digital	DVI Compaq 1024*768@ 66Hz	TR-9200 only
Digital	DVI 1280*1024@ 60Hz	TR-9200 only
Digital	DVI 1280*1024@ 75Hz	TR-9200 only
Digital	DVI 1280*1024@ 70Hz	TR-9200 only

2.2 Panel Controls and OSD Functions

Controls	Description
Power On/Off switch	Soft power on/off button. Adjacent LED is lit when on.
Auto	Auto-synchronize and scale down display to any valid factory preset timings.
▲	Press to scroll the function you want to adjust.
▼	Press to scroll the function you want to adjust.
Menu	To access the main menu. This button also acts as the “Enter” button.



2.2.1 Auto tuning

1. Press the “AUTO” button. The panel will adjust the display size automatically and also tune the panel to its best condition.
2. The OSD of the TR-9200/TR-9300 is GUI (graphic user’s interface) oriented.

In many selections the icon  stands for “accept or yes”, while stands  for “abandon or no”.

2.2.2 Input signal (TR-9200 only)

The TR-9200 accepts two different types of input signals: analog VGA and DVI-D.

1. Press the “MENU” button.
2. Select  “input mode”
3. Input 1  is analog, while input 2  is DVI input.
4. Select correct one and return to main menu.
5. The TR-9300 together with its 3-in-1 KVM cable can accept analog VGA signal only.



2.2.3 Brightness/contrast

1. Press the “MENU” button.
2. Select  “brightness/contrast”

3. There are 3 characteristics to be adjusted:  brightness,  contrast and,

 black level.

4. Use the  and  buttons to tune adequate levels .





2.2.4 Color

1. Press the “MENU” button.

2. Select  “color”

3. Press  makes the system automatically configure the colors.

4. Select  color temperature. Then users can either select  to adjust separate R, G, B values to obtain a satisfactory setting, or choose anyone among 4200K, 5000K, 6500K, 7500K and 9300K as desired color temperature.



2.2.5 Image quality

1. Press the “MENU” button

2. Select  “image quality”. The available characteristics to be tuned including:

 auto configuration

 horizontal display size

 phase

 horizontal display position

 vertical display position

 sharpness



2.2.6 Miscellaneous settings

1. Press the “MENU” button.

2. Select  “tools”.

3. Select  OSD settings. Users can adjust the following items about OSD:

 OSD horizontal position

 OSD size

 OSD timeout

 V OSD vertical position

4. Press the  can restore original factory settings.



2.2.7 Power Indicator

- ◆ GREEN ON
- ◆ ORANGE STANDBY
- ◆ ORANGE SUSPEND
- ◆ ORANGE OFF

Note : OSD – On Screen Display

CHAPTER 3 INSTALLATION

3.1 Installing the Video Card and Video Driver

Before connecting the TR-9200 and TR-9300, make sure your computer has a video card already installed for the monitor. After you connect the drawer, install the video software driver. The video driver is supplied by the video card manufacturer and may be found on the CDROM that came with your computer. If you need information on installing a video card or video driver, refer to the manual that came with your video card.

3.1.1 Configuring the Display Settings

After connecting the drawer and turning on your computer, you may need to configure one or more of the following display settings:

- ✧ Display mode (also called desktop area or video resolution)
- ✧ Refresh rate (also called vertical scan rate or vertical sync)
- ✧ Color depth (also called color palette or number of colors)

Each video card has several controls that let you adjust the display settings. However, the software and driver for each video card is unique. In most cases, you adjust these settings by using a program or utility provided by the manufacturer of the video card. Most video cards use the Windows Display Properties control panel to configure the display. To open the Windows Display Properties, click the right mouse button in a blank area of the Windows desktop and then select **Properties**. The Settings tab usually lets you change the Color Palette and the Desktop Area (x by y pixel resolution).

Some video cards integrate additional features into the Windows Display Properties control panel to give you an exceptional setup that is flexible and easy to use. For example, the control panel may include an Advanced Properties button, an Adjustment tab, or a Refresh tab for changing other settings. Other video cards have a separate utility for setting display properties.

Whenever you change the resolution, color, or refresh rate, the image size, position, or shape may change. This behavior is normal. You can readjust the image using the monitor on-screen controls. For more information on the monitor on-screen controls, refer to Chapter 2. For more information on configuring the display settings, refer to the manual that came with your video card.

3.2 Connecting the Drawer

To connect an TR-9200 and TR-9300 monitor/keyboard drawer to a computer, perform the following steps:

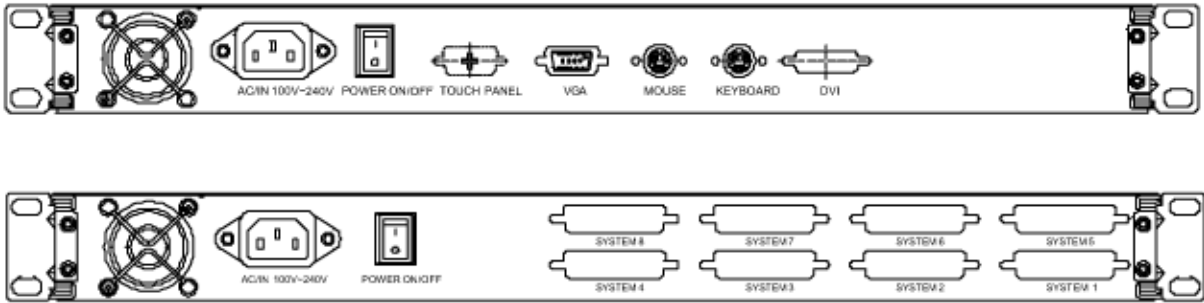

The rear view of the TR-9200/TR-9300

1. Turn off your computer. You should always turn off your computer before connecting or disconnecting a device.
2. Connect the KVM cable to the “System 1” connector on the monitor/keyboard drawer.
3. Connect the video (VGA) connector of the KVM cable to the video card connector on the rear panel of your computer.
4. Identify and connect the PS/2 mouse and PS/2 keyboard connector to the correct PS/2 ports on the rear panel of your computer.
5. Connect the AC power cord to the power inlet on the drawer and then to a power outlet.
6. If the TR-9200 is used, step 2 & 3 should be skipped. Users need only connect the TR-9200 VGA in port to computer system’s VGA out port.

NOTE: Please refer to chapter 4 for more information about the TR-9300.

3.3 Turning On the Drawer

Make sure all cables and the power cord are connected properly. Be sure to tighten all connector screws. Using two hands, grasp the rear of the drawer, lift the tab and pull the panel up and forward. This will disengage the momentary on/off switch and the unit should power on. The LED on the left of the monitor panel should turn from orange to green, verifying that the unit is operational.

3.4 Testing the Drawer

To test that the drawer is working properly, perform the following steps:

1. Power up the monitor/keyboard drawer, and then turn on your computer.
2. Make sure the video image is centered within the screen area. Use the OSD controls to adjust the image (see note below) or press the Auto button on the right hand side of the monitor.

Note: If the unit does not power up when the panel is pulled up, try pushing the soft power on/off button on the left side of the monitor panel to power up the unit. You can adjust the horizontal and vertical position, contrast, and brightness to

better suit your video card and your personal preference. Refer to Chapter 2 for more information on using the on-screen menu to adjust the video display. Before you begin, make sure that power to all the devices you will be connecting up have been turned off. To prevent damage to your installation due to ground potential difference, make sure that all the devices on the installation are properly grounded. Consult your direct vendor for any technical issues if necessary.

CHAPTER 4 KVM Switch (TR-9300 only)

4.1 Features

- ◆ Cascadable To Three Levels - Control Up to 512 Computers from a Single Console
- ◆ No Software Required - Computer Selection via Front Panel Switches, Hot Keys, or OSD (On Screen Display)
- ◆ Quick View Scan Feature for Monitoring Selected Computers
- ◆ PS/2 Mouse Emulation Provided For System Bootup
- ◆ Console's PS/2 Mouse Controls All Connected Computers
- ◆ PS/2 Compatible Mouse Support - Microsoft Intellimouse Explorer and Logitech FirstMouse+ Support*
- ◆ SVGA, VGA and Multisync Monitor Support
- ◆ LED Display For Easy Status Monitoring
- ◆ Supports High Quality CS Series Custom Connector Cables
- ◆ Hot Pluggable - Add or Remove Computers for Maintenance Without Powering Down the Switch

Note: PS/2 compatible mouse support is for three button (wheel) mice. The Logitech Mouse Ware program's *Change Device* procedure does not work on Microsoft NT systems.

4.2 Installation of TR-9300

4.2.1 Before You Begin



Make sure that power to all the devices you will be connecting up have been turned off. To prevent damage to your installation due to ground potential difference, make sure that all devices on the installation are properly grounded. Consult your dealer for technical details, if necessary.

4.2.2 Single Station Installation

In a Single Stage installation, there are no additional KVM switch daisy chained down

from the TR-9300. To set up a single stage installation, do the following:

1. Use connector cable sets (as described in the Hardware Requirements section), to connect any available monitor, keyboard and mouse ports of the computer you are installing.
2. Plug the adapter cable into the TR-9300's power jack, then plug the power adapter into an AC power source.
3. Turn on the power to the computers

4.2.3 Two Station & Three Installation

With the combination of KVM switch box, you can cascade up to two or three levels. For two or three stage installation, please refer to the manuals in the KVM switch box.

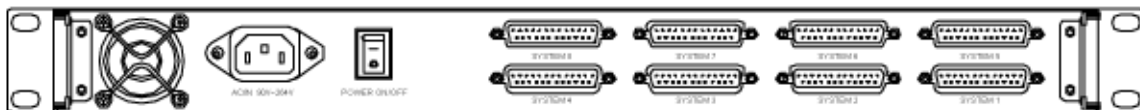

The rear view of the TR-9300

Note: We strongly recommend you directly contact your dealer for KVM switch boxes.

4.2.4 Front View

1. Port LEDs

On Line:Lights ORANGE to indicate that the computer attached to the corresponding port is up and running. If the LED is flashing, it indicates that the Port is being used for Cascading to another Master View switch.

Selected:Lights GREEN to indicate the currently selected port. The LED is steady under normal conditions, but flashes when its port is accessed under *Auto Scan* mode.

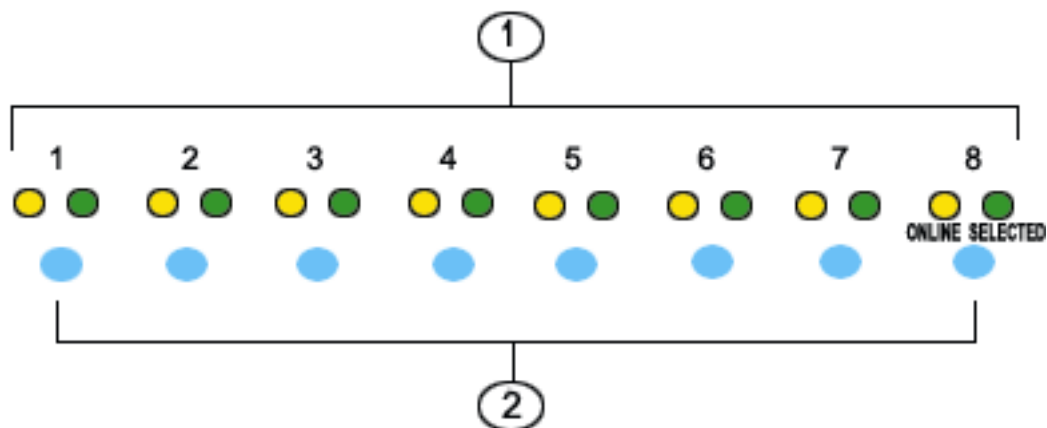

2. Port Selection Switches

Press a switch to access the computer attached to the corresponding port

- ◆ Pressing Buttons 1 and 2 simultaneously for 3 seconds performs a Keyboard and Mouse reset
- ◆ Pressing Buttons 7 and 8 simultaneously starts Auto Scan Mode.

4.3 Hot Plugging

The TR-9300 supports hot plugging - components can be removed and added back into the installation by unplugging their cables from the platform ports without the need to shut the unit down. In order for hot plugging to work properly, these procedures must be followed: When hot plugging cables from the platform ports, the cable must be plugged back into the same port it was removed from.

4.3.1 Powering Off and Restarting

If it becomes necessary to Power Off one of the TR-9300 units, before starting it back up you must do the following:

1. Shut down all the computers that are attached to it.
2. Unplug the power adapter cable.
3. Wait 10 seconds, then plug the TR-9300 stations back in, starting with the last station in the chain and working back to the station you originally shut down.
4. After the TR-9300 is, power On the computers, starting with the ones attached to the last station in the chain and working back to the station you originally shut down.

4.3.2 Port Selection

The TR-9300 provides three methods to obtain instant access to any computer in your installation: Manual; *Hotkey*; and OSD.

- ◆ Manual

Simply press the appropriate *Port Selection Switch* on the TR-9300's front panel. After you press the switch, the *Selected* LED lights to indicate that the port is currently selected. The OSD automatically switches to highlight the computer that you have selected.

Note: Simultaneously pressing Port Selection buttons 7 and 8 on the First Stage unit initiates the *Quick View Scan* feature, in which all the ports that are selected for Quick View scanning are cycled through. The length of time spent on each port is determined with the OSD . s **F6 SET** function (see the *OSD Operation* section for details).

- ◆ Hot Key Navigation

Hotkey navigation allows you to conveniently access any computer directly from the keyboard, instead of having to manually select it with a *Port Selection* switch. To select a port with the *Hotkey* method, do the following:

1. Press **[Ctrl]+[Alt]+[Shift]** to invoke the hotkey function.
2. Key in the **Port ID number** (see *Port ID Numbering*, below), then press [Enter]

Note: Press the keys in sequence - one key at a time.

First [Ctrl], then [Alt], then [Shift].

3. After invoking the hotkey function with the [Ctrl]+[Alt]+[Shift] combination, you must key in the Port ID and press [Enter] within 1 second for each keypress.

- ◆ **OSD**

On Screen Display (OSD), provides a menu driven interface to handle the computer switching procedure. OSD operation is discussed in detail beginning on page 13

4.4 Port ID Numbering

4.4.1 Overview

Each CPU Port on a TR-9300 installation is assigned a unique Port ID. You can directly access any computer of the installation by specifying the Port ID of the CPU Port that the computer is connected to - either with the Hotkey port selection method, or from the OSD Main Menu.

4.4.2 Port Key In Examples:

Access a computer attached to Port 3, key in 3 for the Port ID, as follows:

[Ctrl]+[Alt]+[Shift] 3 [Enter]

4.4.3 Hotkey Summary Table

This Combination	Does This
[Ctrl] + [Ctrl]	Invokes the OSD (Default)
[Scroll Lock] + [Scroll Lock]	Invokes the OSD (Alternate Method)
[Ctrl]+[Alt]+[Shift] [Port ID] [Enter]	Switches access to the computer that corresponds to the Port ID number (see Port Key In Examples, above).
[Ctrl]+[Alt]+[Shift] [0] [Enter]	To invoke Auto Scan mode.

4.5 OSD Operation

4.5.1 Overview

On Screen Display (OSD), provides a menu driven interface to handle the computer switching procedure. Although *Hotkey* switching still works, using OSD is a great deal more convenient - especially in large, daisy chained installations

where it is difficult to keep track of which port a particular computer is attached to. All operations start from the OSD Main Menu. To pop up the Main Menu, tap either **Ctrl** key twice.

Note: 1. The keys must be on the same side (both left, or both right)

2. You can optionally change the hotkey to the Scroll Lock key (see F6, below), in which case you would press [Scroll Lock] twice.

OSD always starts in *List* view, with the highlight bar at the same position it was in the last time it was closed.

The next two sections explain how to navigate using the OSD and Hotkey methods.

PN	QV	PC	NAME
2-5	▶	+	ABC
2-6			XYZ
2-7			
2-8			
3			
4			
5-1			
5-2			

F1 GOTO F2 SCAN F3 LIST F4 QV F5 EDIT F6 SET

4.5.2 OSD Navigation

[Esc] cancels the current selection, or dismisses the current menu and moves back to the menu one level above. If you are at the highest menu level, it deactivates OSD.

Use the Up and Down Arrow Keys or click on the Up and Down Triangle symbols (◀▶) to move up or down through the list one line at a time.

Use [Pg Up] and [Pg Dn] or click on the Up and Down Arrow symbols (▲ ▼) to move up or down through the list one screen at a time

To activate a port, move the Highlight Bar to it then press [Enter].

After executing any action, you automatically go back to the menu one level above.

4.5.3 Hotkey Navigation

Hotkey navigation can also be used under OSD as follows:

From the OSD Main Menu, press [Ctrl]+[Alt]+[Shift].

Key in the Port ID for the computer you wish to access (see *Port ID Numbering*, above), then press [Enter].

The console now controls the computer that you have selected, and the OSD automatically closes.

When you use this method, note the following:

1. Although access switches to the port you just specified, the highlight bar on the OSD screen doesn't move.
2. You must press [Ctrl], [Alt], [Shift] one after the other - not all at the same time.
3. After pressing the [Ctrl]+[Alt]+[Shift] combination, you must key in the Port ID and press [Enter] within 1 second for each keypress.
4. The keys must be pressed and released one key at a time.

5. Number keys must be pressed from the regular keyboard; not from the numeric keypad.
6. If you submit an incorrect Port ID, an error message displays, and you are returned to the OSD Main Menu.

4.5.4 OSD Main Menu Headings:

PN	This column lists the Port ID numbers (Station Number - Port Number) for all the CPU Ports on the installation. The simplest method to access a particular computer is to move the Highlight Bar to it, then press [Enter].
QV	If a port has been selected for Quick View scanning (see F2 and F4, below), an arrowhead displays in this column to indicate so.
PC	Lists all the computers that are Powered On and are On Line.
NAME	If a port has been given a name (see F5, below), its name appears in this column.

4.5.5 The Function Keys:

Pressing a Function Key brings up a submenu that is used to configure and control the OSD. For example, you can: rapidly switch to any port; scan selected ports only; limit the list you wish to view; designate a port for Quick View scanning; create or edit a port name; or make OSD setting adjustments.

◆ F1 GoTo:

GoTo allows you to switch directly to a port by either of the following two methods:

1. Move the Highlight Bar to the port you want then press [Enter].
2. Key in the *Port ID* or *Name*, then press [Enter].

Note: GoTo has a special feature that narrows the list of available choices as you type the name. For example, if the first letter you type is *a*, the list only displays those ports whose names begin with *a*. If the next letter you type is *b*, the list only displays the ports whose names begin with *ab*, etc.

To return to the OSD Main Menu without making a choice, press [Esc].

◆ F2 Scan:

Pressing [F2] initiates *Quick View Scanning*, in which the OSD cycles through all the ports that are currently selected in the *List* view (see F3, below), and displays each one for the amount of time set with the *Set Scan Duration* function (see F6, below). When you want to stop at a particular location, press the [Spacebar] to stop scanning.

Note:

1. If the scanning stops on an empty port, or one where the computer is attached but is powered Off, the monitor screen will be blank, and the mouse and keyboard will have no effect. To recover, key in the *Hotkey* sequence (see *Hotkey Selection*, above), for any Port ID that has an active computer attached.
2. As the OSD cycles through the selected ports, an *s* appears in front of the Port ID display for each computer to indicate that the computer is being accessed under *Quick View Scan Mode*.

◆ **F3 List:**

This function lets you broaden or narrow the scope of which ports the OSD lists. The choices and their meanings are given in the table, below:

Choice	Meaning
ALL	To list the Port ID numbers and Names (if names have been specified - see F5), of all the ports on the installation.
QVIEW	To list only the ports that has been selected for Quick View scanning (see F4, below).
POWERED ON + QVIEW	To list only the ports that have been selected for Quick View scanning (see F4, below), and that have their attached computers Powered On.
QVIEW + NAME	To list only the ports that has been selected for Quick View scanning (see F4, below), and has been assigned names (see F5, below).
NAME	To list only the ports that has been assigned names (see F5, below).
POWERED ON	To list only the ports that have the attached computers powered on.

To make a choice, move the Highlight Bar to the one you want, then press [Enter]. An icon appears before the choice to indicate that it is the currently selected one.

Note:

1. You can access any port on any list by using the Navigation Keys then pressing [Enter].
2. If you select a port that does not have a computer attached to it, or if the attached computer is powered Off, the OSD will still switch to it, and will not show an error.

◆ **F4 QV:**

QV lets you select the ports you want to include for automatic scanning under the Quick View Scanning function (see F2, above). [F4] is a toggle: if a port isn't selected, it selects it; if a port is selected, it deselects.

To select/deselect a port, move the highlight bar to it, then press [F4].

When a port has been selected, an arrowhead displays in the QV column to indicate so. The arrowhead disappears when a port is deselected.

◆ **F5 Edit:**

To help remember which computer is attached to a particular port, every port can be given a name. The Edit function allows you to create, modify, or delete port names. To Edit a port name:

1. Move the highlight bar to the port you want to edit.
2. Press [F5].
3. Key in the new Port Name, or modify/delete the old one.

The maximum number of characters allowed for the Port Name is 15. Legal characters include:

- ◆ All alpha characters: a - z; A - Z
- ◆ All numeric characters: 0 - 9
- ◆ +, -, /, :, ., and Space

Case does not matter; OSD displays the Port Name in all capitals no matter how they were keyed in.

4. When you have finished editing, press [Enter] to have the change take effect. To abort the change, press [Esc].

◆ **F6 Set**

Pressing [F6] brings up an OSD configuration menu. To change a setting:

1. Move the highlight bar to the choice you want, then press [Enter].
2. On the submenu that appears next, move the highlight bar to the choice you want and press [Enter].

An icon of a pointing finger indicates which choice is the currently selected one.

An explanation of the choices is given in the table, below:

Setting	Function
CHANNEL DISPLAY MODE	To select how the Port ID is displayed: the Number plus the Name (PN + NAME); the Number alone (PN); or the Name alone (NAME).
CHANNEL DISPLAY DURATION	To determine how long a Port ID displays on the monitor after a port change has taken place: 3 Seconds ; or Always On .
CHANNEL DISPLAY POSITION	To position where the Port ID appears on the screen. Use the Arrow Keys, Pg Up, Pg Dn, Home, End, and 5 (on the numeric keypad with Num Lock off), to position the Port ID display, then press [Enter] to lock the position and return to the Set Submenu.
SCAN DURATION	To determine how long the display dwells on each port as it cycles through the selected ports in Quick View Scan Mode. The available options are: 3, 5, 10, 15, 20, 30, 40, and 60 seconds.
OSD ACTIVATING HOTKEY	To select which Hotkey activates the OSD function: [Ctrl] [Ctrl] or [Scroll Lock] [Scroll Lock] . The default is the Ctrl key combination, but this may conflict with programs running on the computers, in which case, the Scroll Lock option should be used.
SET PASSWORD	To set a password in order to control access to: Locking/Unlocking the Console; Clearing the Name List; and Restoring Default Values. See <i>OSD Security Features</i> , below, for password setting details.
CLEAR THE NAME LIST*	To clear all Port Names from the Name List. You are asked to confirm before the procedure goes on. Key in Y , then press [Enter] to confirm. While the names are being cleared, a message appears on the display to indicate so. After the names have been cleared, another message appears to indicate that the procedure completed successfully.
RESTORE DEFAULT VALUES*	To clear all settings from memory, and returns the unit to the factory defaults. You are asked to confirm before the procedure goes on. Key in Y , then press [Enter] to confirm. While the settings are being cleared, a message appears on the display to indicate so. After the settings have been cleared, another message appears to indicate that the procedure completed successfully.
LOCK CONSOLE*	To lock or unlock the Console. When the Console is locked, only the current monitor screen displays. Attempts to input information from the console have no effect; attempts to switch to a different port, either from the Console or by pressing the manual switches, have no effect either. The only way to regain access to the computers is by Unlocking the Console. If a password has been set, you must provide the password in order to Lock / Unlock the Console. If no password has been set, pressing [Enter] will Lock / Unlock the Console.

* If a password has been set, these settings require you to supply a proper password in order to access them. See the *OSD Security* section, below, for details.

4.5.6 Factory Default Settings

The factory default settings are as follows:

Setting	Default
Display Duration	Always On
Display Mode	The Port Number plus the Port Name
Scan Duration	3 Seconds

4.5.7 OSD Security

In order to prevent unauthorized access to the computers, the OSD provides a password security feature. If a password has been set, the OSD will request that the user specify it before allowing entry. To set a password:

1. Press [F6] to bring up the Setup configuration menu.
2. Move the highlight bar to *Set Password*, then press [Enter].
3. Key in the new password, then press [Enter].

The password may be up to 8 characters long, and can consist of any combination of letters and numbers (A - Z, 0 - 9).

4. Key in the new password again, in order to confirm that it is correct, then press [Enter].

If the two entries match, the new password is accepted and the screen displays the following message:

SET PASSWORD OK

If the entries do not match, the screen displays the message:

PASSWORD NOT MATCH

in which case you must start again from the beginning.

Note: To modify or delete a previous password, access the Password function as in Step 1, then use the backspace or delete key to erase the individual characters.

4.6 Trouble Shooting

Symptom	Possible Cause	Action
Erratic Behavior	Unit not receiving enough power under self-powered operation.	Use the Power Adapter that was supplied with the unit to provide external power.
Pressing Hot Keys gets no response	The connection from the selected port to the target computer has been broken, or the computer is turned OFF.	Check the Online LED for the selected port. If it is not lit: Manually press one of the Select switches to connect to a computer that is powered ON. Check the cables to make sure they are all properly connected.
	Improper keyboard reset.	Reset the keyboard (and mouse) by simultaneously pressing Buttons 1 and 2 on the First Stage unit for 3 seconds. Unplug the keyboard connector from the Console Keyboard Port, then plug it back in.
	Improper Master View reset.	Turn off all Master View units and wait five seconds before turning them back on. Note: If the unit is operating under Self-powered mode (without the optional Power Adapter), you must unplug the power cords of any computers that have the <i>Keyboard 'Power On'</i> function, otherwise the switch will still receive power from the computers.
	Incorrectly keying in the Port ID.	After invoking the hotkey function with [Ctrl]+[Alt]+[Shift] combination, be sure to key in the Port ID and press [Enter] within 1 second for each key.
Mouse not responding	Improper mouse reset.	Reset the mouse (and keyboard) by simultaneously pressing Buttons 1 and 2 on the First Stage unit for 3 seconds. Unplug the mouse connector from the Console Mouse Port, then plug it back in.

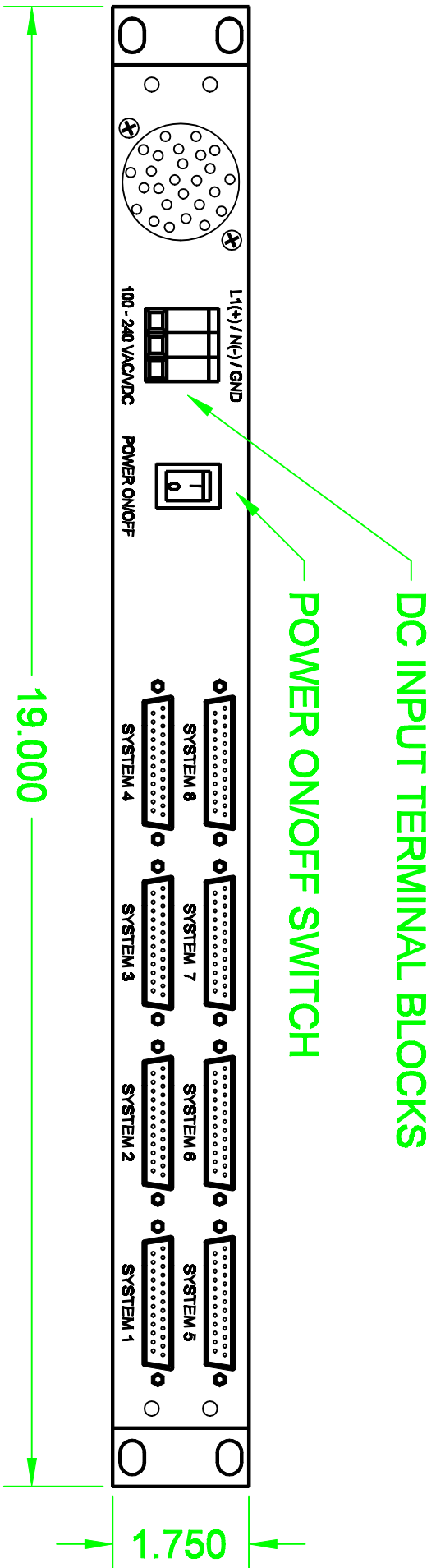

DC INPUT TERMINAL BLOCKS

POWER ON/OFF SWITCH

REAR VIEW

DATE	10-10-2006	DRAWN BY	B.G.	MODEL	TR-9300
MATERIAL					
FINISH		Transduction		CHECKED BY	NTS
TITLE	1U KVM SWITCH		DRAWING No	B-392	
				REVISION	SCALE

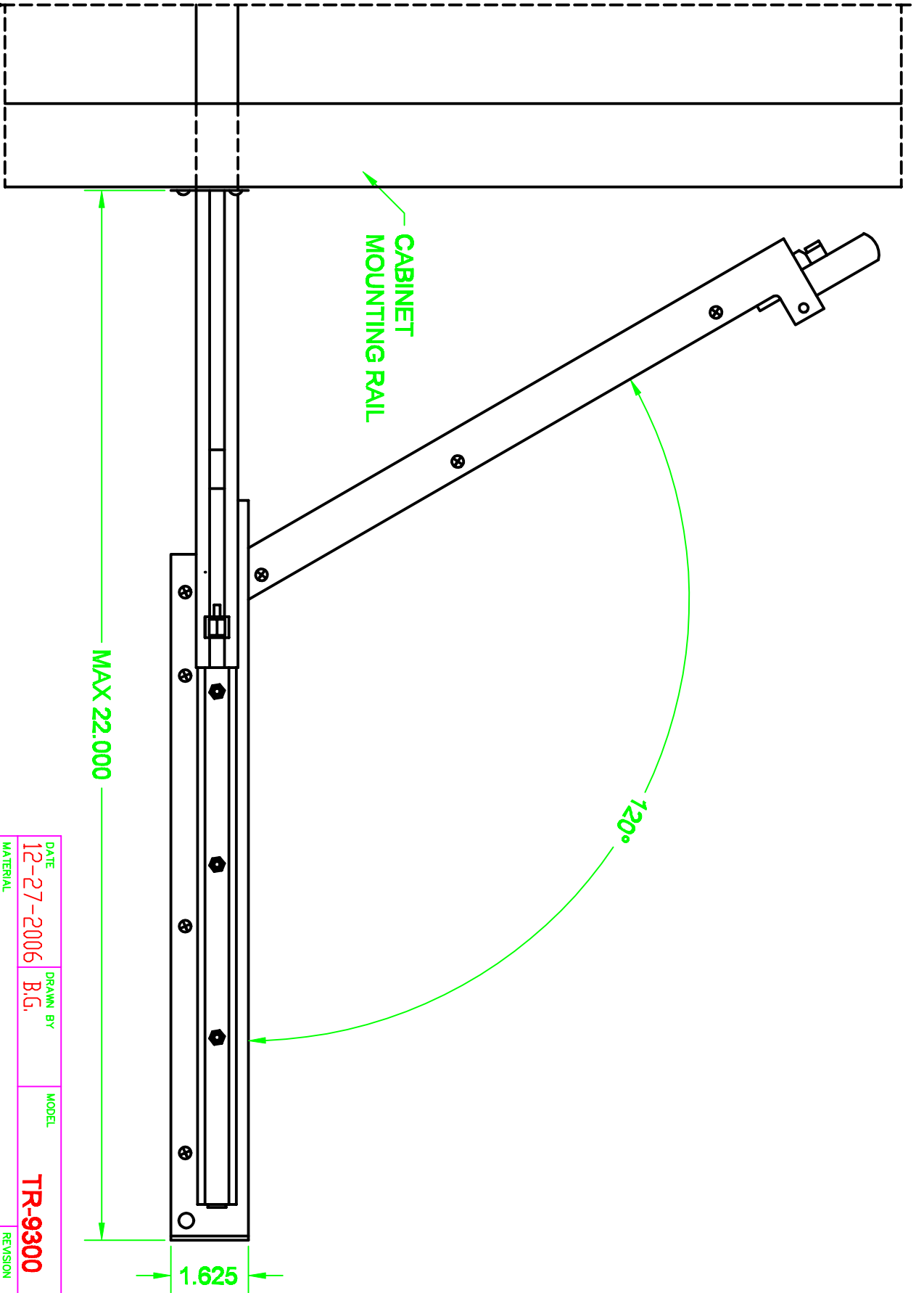

CABINET
MOUNTING RAIL

120°

MAX 22.000

1.625

SIDE VIEW

DATE	12-27-2006	DRAWN BY	B.G.	MODEL	TR-9300
MATERIAL					
FINISH		Transduction		CHECKED BY	NTS
TITLE	1U KVM SWITCH			DRAWING No	B-393
				SCALE	