

# TRANSDUCTION



USER'S MANUAL

Version 1.0

08/05/09

TR-LCD1500-ITX HALF FANLESS INDUSTRIAL  
PANEL PC WITH INTEL ATOM PROCESSOR  
AND 15" LCD TOUCH SCREEN DISPLAY

5155 Spectrum Way, Mississauga, ON, Canada L4W 5A1

TEL: 1-800-268-0427, 905-625-1907

FAX: 905-625-0531

Email: [sales@transduction.com](mailto:sales@transduction.com)

# Table of Contents

Important Information .....	3
Warranty .....	3
<i>Chapter 1 - Introduction</i> .....	4
TR-LCD1500-ITX Specifications .....	5
LCD Display Operation .....	6
TR-LCD1500-ITX SBC Features .....	7
TR-LCD1500-ITX SBC Specifications .....	8-9
<i>Chapter 2 - TR-LCD1500-ITX SBC Jumpers &amp; Connectors</i> .....	10
Section 1 - Jumpers on the TR-LCD1500-ITX SBC.....	11
Jumper Locations on the TR-LCD1500-ITX SBC .....	12
JP1, JP2, JP3: FSB SPD Selection .....	13
JP4: Clear CMOS RAM Data .....	13
JP5: CF Card Mode Selection .....	14
JP6, JP7: COM Power Selection .....	14
JP8: COM6 Power Pin (Pin 9) .....	14
LCDPWR: LCD Panel Power Selection .....	15
AT Mode: AT Mode Selection .....	15
COM2MODE: RS232/422/485 .....	16
Section 2 - Connectors on the TR-LCD1500-ITX SBC .....	17
Connector Locations on the TR-LCD1500-ITX SBC ...	18
Front Panel Connector .....	19-20
BACKLIGHT Connector .....	21
TV-OUT Connector .....	21
IRDA Connector .....	22
IDE Connectors .....	23
COM1 Serial Ports .....	24
COM2 Serial Ports .....	24
COM3, COM4, COM5 Serial Ports .....	25
COM6 Serial Ports .....	26
LPT Port .....	27
PS/2 Keyboard & Mouse Connector .....	28
VGA Connector .....	28
INT_VGA Connector .....	29
INT_KBMS Connector .....	29
DC_IN1 Connector .....	30
DC_IN2 Power Connector .....	30
CPU Fan Power Connector .....	30

# Table of Contents

Section 2 - Connectors on the TR-LCD1500-ITX SBC (Cont'd)	
System Fan Power Connector .....	31
DRVPOWER Connector .....	31
USB56 USB78 Connectors .....	31
LANGbE+USBx2 Connectors .....	32
LAN-GbE Connectors .....	32
LAN RJ45 LED1,2 .....	33
Audio Connectors .....	33
INT_Audio Connectors .....	34
LVDS LCD Connector .....	35
DIO Connector .....	36
SATA1, SATA2 Connectors .....	36
CF-II Connector .....	37
Chapter 3 - BIOS Setup .....	38
Main Menu .....	39-45
Standard CMOS Features .....	46-50
Advanced BIOS Features .....	51-57
Advanced Chipset Features .....	58-62
Integrated Peripherals .....	63-79
Power Management Setup .....	80-85
PnP/PCI Configurations .....	86-89
PC Health Status .....	90-91
Frequency/Voltage Control .....	92
Load Fail-Safe Defaults .....	92
Load Optimized Defaults .....	93
Set Supervisor/User Password .....	93-95
Save & Exit Setup .....	95
Exit Without Saving .....	96
Appendix .....	97
AC Power Adapter .....	98
I/O Port Address Map .....	99
Interrupt Request Lines (IRQ) .....	100
POST Beep .....	101
Resistive Touch Screen Option .....	102-108
TR-LCD1500-ITX Mechanical Drawings .....	109-120

# Important Information

The information in this document is subject to change without notice.

All relevant issues have been considered in the preparation of this document. Should you notice an omission or any questionable item in this document, please feel free to notify Transduction.

Regardless of the foregoing statement, Transduction assumes no responsibility for any errors that may appear in this document nor for results obtained by the user as a result of using this product.

## **Copyright © 2009 Transduction. All rights reserved.**

This document is protected by copyright. No part of this document may be reproduced, copied or translated in any form or means without prior written permission from Transduction.

All other trademarks, brand and product names are the property of their respective owners.

## **Return policy**

Warranty is 3 years for the whole system from the date of purchase. Products returned for repair must be accompanied by a Return Material Authorization (RMA) number, obtained from Transduction prior to return.

Freight on all returned items must be prepaid by the customer. The customer is responsible for any loss or damage caused by the carrier in transit.

To obtain an RMA number, call us at 905-625-1907. We will need the following information:

- Return company address and contract
- Model name, model number and serial number
- Description of the failure

Mark the RMA number clearly on the outside of each box, include a failure report and return the product to:

### **Transduction**

**5155 – 23 Spectrum Way**

**Mississauga ON Canada L4W 5A1**

**Attn: RMA Department**

## ***Product Description***

### **TR-LCD1500-ITX is a NEMA 4 Panel/Rack Mount Industrial Computer.**

TR-LCD1500-ITX industrial computer with or without touch screen has been designed to provide many years of reliable operation in industrial environments. The warranty is 3 years but MTBF based on service records is in excess of 100,000 hours.

Based on the ATOM 1.6GHz processor, TR-LCD1500-ITX provides a low cost alternative to comparable products offered by our competitors costing 3 times more.

Designed by Transduction this computer is manufactured in Canada with the same high quality standards that we use for military and nuclear clients.

## **Warranty**

Warranty is unconditional for 3 years from the date of Transduction invoice, FOB our plant in Mississauga. Transduction Return Material Authorization (RMA) number must be obtained prior to return of any goods for service and clearly shown on the shipping label. For RMA number call 905-625-1907 ext. 12, 9AM to 5PM Eastern Time Zone.

# 1

---

## Introduction

This manual is designed to give you information on the TR-LCD1500-ITX industrial PC. The topics covered in this chapter are as follows:

TR-LCD1500-ITX Specifications .....	5
LCD Display Operation .....	6
TR-LCD1500-ITX SBC Features .....	7
TR-LCD1500-ITX SBC Specifications .....	8-9

# TR-LCD1500-ITX Specifications

<b>Model</b>	TR-LCD1500-ITX Half Fanless Industrial Panel/Rack Computer
<b>Processor</b>	1.6GHz Intel Atom N270 with hyper-threading support No processor air fans
<b>Chipset</b>	Intel 945GSE and ICH7M
<b>BIOS</b>	Award PnP Ver. 6.0
<b>Display</b>	15" TFT LCD, resolution 1024 x 768 (XGA) Backlight MTBF > 150,000 hours Brightness - 250cd/m <sup>2</sup> , Contrast ratio - 300:1 (brightness and contrast software adjustable) USB resistive touch screen
<b>Memory</b>	DDR2 533MHz 2GB
<b>Display</b>	Intel GMA950 Graphic Engine interface, DB15 SVGA connector
<b>Ethernet</b>	2 x Realtek RT8111C Gigabit LAN External RJ45 connectors
<b>External I/O</b>	1 x SVGA DB15 - mirror of LCD 2 x serial ports 1 x parallel port 4 x USB 2.0 ports 2 x RJ-45 LAN port PS2 keyboard and mouse
<b>Disk I/O</b>	Optional SLIM CD-R/W-DVD 2.5" SATA high speed Flash 32GB ~ 256GB or 2.5" SATA hard drive
<b>Green Function</b>	Power saving mode includes doze, standby and suspend modes
<b>Watchdog Timer</b>	System reset programmable watchdog timer with 1 ~ 255sec time-out value
<b>Operating Temperature</b>	0 ~ 50°C (32° ~ 122°F) with hard drive 0 ~ 60°C (32° ~ 140°F) for 2 hours with SSD
<b>Storage Temperature</b>	-20 ~ 85°C (-4° ~ 185°F)
<b>Cooling</b>	2 x redundant ball bearing air fans
<b>Shock and Vibration</b>	Shock - 25G, Vibration - 5G
<b>Humidity</b>	10 ~ 95% relative humidity, non-condensing
<b>Power Requirement</b>	Universal AC power input 100 ~ 240VAC, 100W without fan Optional DC input 125V and 250VDC
<b>Warranty</b>	3 year warranty
<b>Ordering Information</b>	TR-LCD-1500-ITX - Half Fanless embedded system with Intel ATOM 1.6GHz CPU and 2.5" SATA SSD or SATA hard drive
	<b>Compatible with Windows XP 32-bit, Windows 2000, QNX and LINUX kernel 2.4.16 or above</b>

---

## LCD Display Operation

1. LCD Monitor screen is always connected via internal LVDS interface. It can be disabled in the BIOS set-up.
2. External analog SVGA port is the "mirror" of the LCD screen for connection of the external monitor.
3. LCD display settings can be changed in SET-UP section of the video driver.
4. For touch screen installation and calibration is "Resistive Touch Screen Option" section in the appendix of the manual.

---

## ❖ **Features**

- Intel Atom Processor N270 on board.
- 190x135mm only Compact size design with Rich I/O functions.
- Multiple I/O functions: 4 x USB2.0, 2 x COM ports, 1 x SATA, 1x LPT and 2 x Ethernet Gigabit LAN ports.
- Multiple Display functions: Dual 24-bits LVDS LCD and external "mirror" SVGA port.
- Wider range of temperature with half-fanless design.
- Single DC +12V input power with AC/DC adapter.

---

# ❖ Specifications

## **Processor**

- Intel Atom processor N270 on board.
- 1.6GHz Core Speed with Hyper-threading support.
- 533MHz front side bus speed.

## **BIOS**

- Award Standard PnP Flash BIOS 6.0.
- 8Mbit FlashROM with BootBlock for Fail-safe.

## **System Memory**

- Two DDR2 SO-DIMM Sockets.
- DDR2-533 non-ECC memory 2.0 GB.

## **Chipset**

- Intel 945GSE and ICH7M chipset.

## **Video**

- Intel 945GSE Integrated GMA950 graphic engine.
- One D-Sub Female connector for CRT displays.
- One 40-pins connector for Dual 18/24-bits LVDS LCD.
- One 20-pins connector for DVI displays (option).
- One Mini-DIN 7-pins connector to support TV-OUT
- Support dual Independent display, Display devices can be selectable by BIOS or graphic drivers.

## **10/100M/1000M Ethernet**

- Two Realtek RT8111C on board for Dual Gigabit LAN support.

## **On Board I/O**

- Winbond 83627HF LPC I/F Super I/O chip.
- Six serial ports as COM1~COM6. COM2 is RS232/422/485 selectable by jumper.
- COM1 and COM2 are D-Sub 9-pins male on rear panel. Pin9 is powered with either +5V or +12V by jumper.
- COM3~COM6 are pin-headers for internal connections.
- One Parallel port supports SPP/ECP/EPP mode.
- 1 x IrDA port.

---

### ***PIDE and SATA***

- PIDE controller built in ICH7M support up to UltraDMA mode 5 or ATA100 speed.
- One standard 44-pins box header to supports 2.5" HDD or DOM Flash Disk.
- Two SATA connectors from ICH7M support SATA-I and SATA-II devices.
- One 50-pins CF-II socket for Compact Flash Card.

### ***Watchdog Timer***

- Programmable watchdog timer for 1~255 seconds.

### ***CMOS***

- On-board RTC with 242 bytes of Battery-back CMOS RAM.

### ***Audio***

- RealTek ALC888 High-Definition Audio chip on-board.
- Two Audio-Jacks on rear for Audio Line-OUT and MIC.

### ***Power***

- Single DC 12V input with 4-pins Mini-DIN connector.
- Supplies +5V and +12V output power for peripheral devices and LCD panel

### ***Software Compatibility***

- Microsoft windows: Win2K, Win XP 32-bits, Vista 32-bits.
- Linux 32-bits and DOS 6.22.

### ***Cooling***

- Two external redundant cooling FANS operating at reduced speed to prevent intake of dust.

### ***Dimensions***

- 190mm (W) x 135mm (L).
- 4 screw holes on four corners.

### ***Operating Temperature***

- 0 to 50°C operating range, 60°C for 2 hours.
- 0 to 60°C with high temperature LCD.
- Relative Humidity: 5~95%, non-condensing.

# 2

---

## Jumper Settings & Connectors

This chapter provides information on the TR-LCD1500-ITX SBC jumper settings and internal and external connectors. The topics covered are as follows:

Section 1 - Jumpers on the TR-LCD1500-ITX SBC .....	11-16
Section 2 - Connectors on the TR-LCD1500-ITX SBC .....	17-37

# 2 Section 1

---

## Jumpers on the TR-LCD1500-ITX SBC

The jumpers on the TR-LCD1500-ITX SBC allow you to configure your board according to the needs of your applications. The following table lists the jumpers on TR-LCD1500-ITX SBC and their respective functions.

Jumper Locations on the TR-LCD1500-ITX SBC .....	12
JP1, JP2, JP3: FSB SPD Selection .....	13
JP4: Clear CMOS RAM Data .....	13
JP5: CF Card Mode Selection .....	14
JP6, JP7: COM Power Selection .....	14
JP8: COM6 Power Pin (Pin9) .....	14
LCDPWR: LCD PANEL Power Selection .....	15
AT MODE: AT Mode Selection .....	15
COM2MODE: RS232/RS422/RS485 .....	16

---

# Jumper Locations on the TR-LCD1500-ITX SBC

---

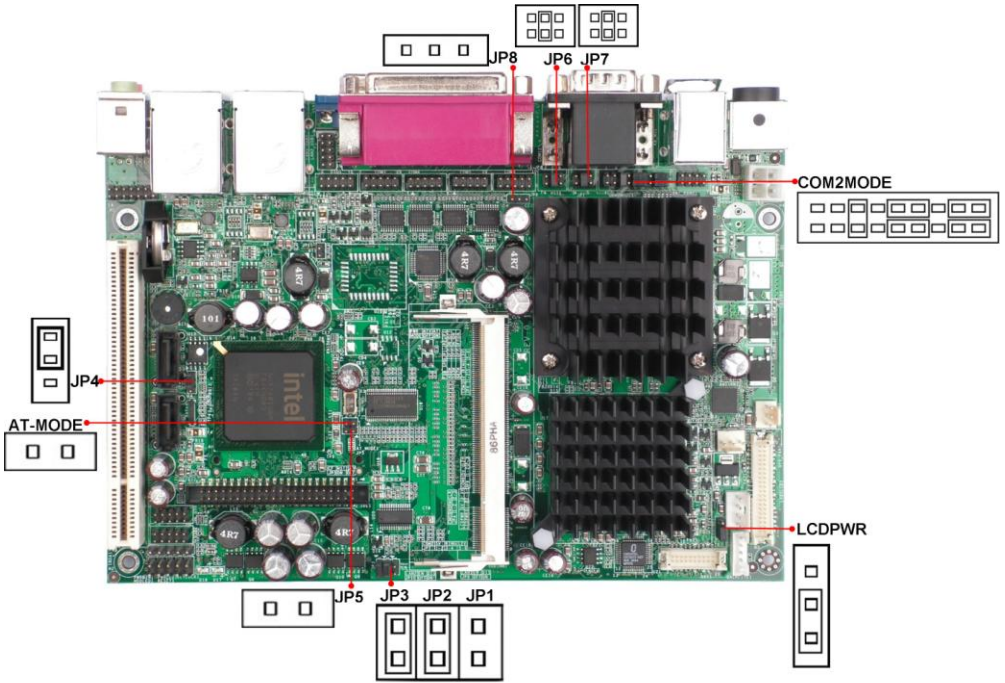

---

## JP1, JP2, JP3: FSB SPD Selection

---

JP1 and JP2 and JP3 allow users to select the CPU FSB speed. It can be 533M or 667M. User should select the correct FSB speed to make their CPU run on correct speed and ensure the system runs stably.

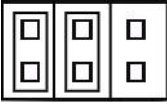
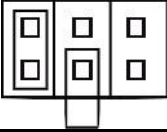
FSB SPD	JP1~JP3
533M	<p>JP3 JP2 JP1</p> 
667M	<p>JP3 JP2 JP1</p> 



---

## JP4: Clear CMOS RAM Data

---

This 3-pin Jumper allows the user to disconnect the built-in 3V battery power to clear the information stored in the CMOS RAM. To clear the CMOS data:

- (1) Turn off the system power,
- (2) Remove Jumper cap from pin1&2,
- (3) Short the pin2 and pin3 for three seconds,
- (4) Put Jumper cap back to pin1 & 2.
- (5) Turn on your computer,
- (6) Hold Down <Delete> during boot up and enter BIOS setup to enter your preferences.

COMS	NORM	CLR
JP4	<p>1-2</p> 	<p>2-3</p> 

---

## JP5: CF Card Mode Selection

---

This Jumper is to select the CF works as Secondary Channel Master device or Slave device.

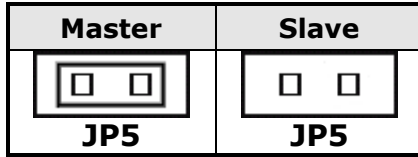

---

## JP6, JP7: COM Power Selection

---

JP6, JP7 can be used to select the COM supply power: +5V, Ring-IN or +12V.

JP6: COM1 Pin9 power or Ring-IN

JP7: COM2 pin9 power or Ring-IN

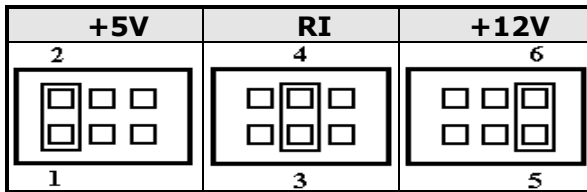

---

## JP8: COM6 Power Pin (Pin9)

---

JP8: COM6 Pin9 power.

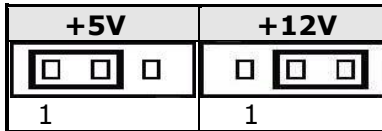

---

## LCDPWR: LCD PANEL Power Selection

---

LCDPWR can be used to select the Panel LCD supply power: +3.3V or +5V. The default setting is on +3.3V. User need to check the LCD panel spec and adjust this jumper to make Panel work in specified power rail. This Jumper serves LVDS LCD connector.

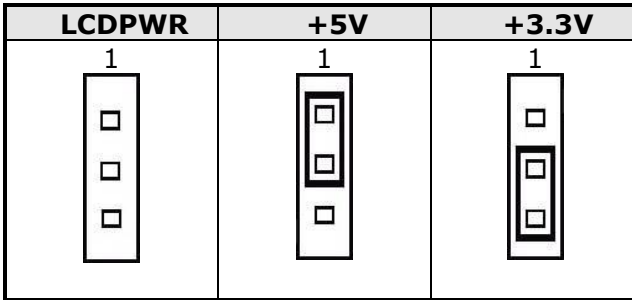

---

## AT MODE: AT Mode Selection

---

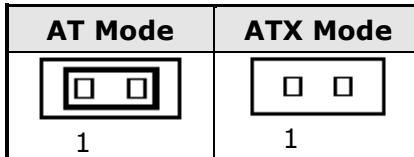

---



## COM2MODE: RS232/RS422/RS485

---

COM2 support multi-protocols include RS232, RS422 and RS485, while COM3, COM4, COM6 and COM6 support diffused RS232 protocol.

The Protocols of COM2 can be set up through jumpers. COM2MODE: COM2 Protocols selection.

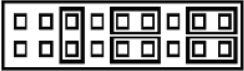
The pin-out for each mode is illustrated on next chapter.

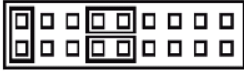
COM2MODE1	I/F TYPE
<b>2</b> <span style="float: right;"><b>18</b></span> 	<b>RS-232</b>
<b>1</b> <span style="float: right;"><b>17</b></span> <b>2</b> <span style="float: right;"><b>18</b></span> 	<b>RS-422</b>
<b>1</b> <span style="float: right;"><b>17</b></span> <b>2</b> <span style="float: right;"><b>18</b></span> 	<b>RS-485</b>

# 2 Section 2

---

## Connectors on the TR-LCD1500-ITX SBC

The connector on the TR-LCD1500-ITX SBC allows you to connect external devices such as keyboard, floppy disk drives, hard disk drives, printers and etc. The following table lists the connectors on TR-LCD1500-ITX SBC and their respective page number.

Connector Locations on the TR-LCD1500-ITX SBC .....	18
Front Panel Connector .....	19-20
BACKLIGHT Connector .....	21
TV-OUT Connector .....	21
IRDA Connector .....	22
IDE Connectors .....	23
COM1 Serial Ports .....	24
COM2 Serial Ports .....	24
COM3, COM4, COM5 Serial Ports .....	25
COM6 Serial Ports .....	26
LPT Port .....	27
PS/2 Keyboard & Mouse Connector .....	28
VGA Connector .....	28
INT_VGA Connector .....	29
INT_KBMS Connector .....	29
DC_IN1 Connector .....	30
DC_IN2 Power Connector .....	30
CPU Fan Power Connector .....	30
System FAN Power Connector .....	31
DRVPOWER Connector .....	31
USB56 USB78 Connectors .....	31
LANGbE+USBx2 Connectors .....	32
LAN- GBE Connectors .....	32
LAN RJ45 LED1, 2 .....	33
Audio Connectors .....	33
INT_AUDIO Connector .....	34
LVDS LCD Connector .....	35
DIO Connector .....	36
SATA1, SATA2 Connectors .....	36
CF-II Connector .....	37

# Connector Locations on the TR-LCD1500-ITX SBC

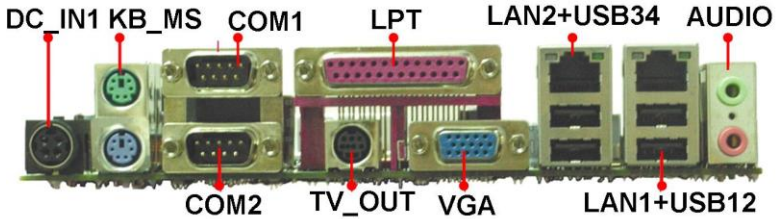
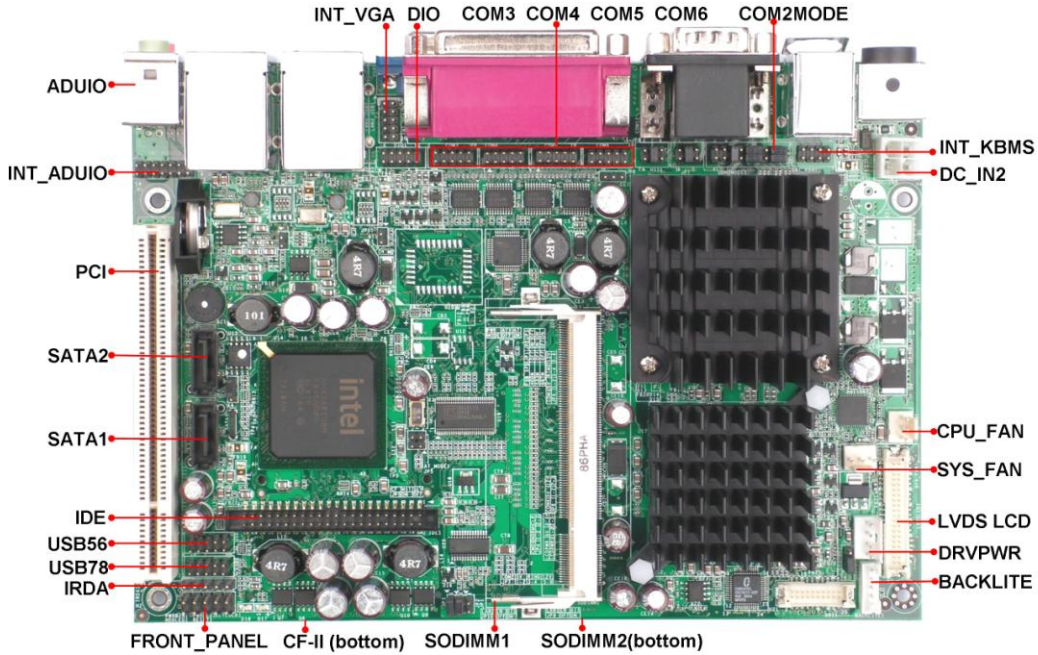

## Front Panel Connector

The front panel of the case has a control panel, which provides light indication of the computer activities and switches to change the computer status.

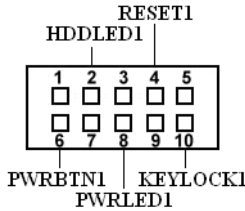

### ➤ ATX Power ON/OFF Button

This 2-pin connector acts as the "Power Supply On/Off Switch" on the TR-LCD1500-ITX SBC. When pressed, the switch will force the Main board to power on. When pressed again, it will force the main board to power off.

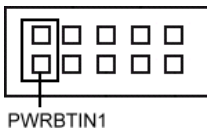

PWR BTN Pin #	Signal Name
1	PWR-BTN
6	GND

### ➤ IDE Hard Disk LED Connector

This connector connects to the hard drive activity LED on control panel. This LED will flash when the HDD is being accessed.

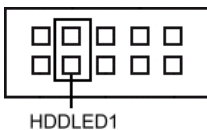

IDE LED Pin #	Signal Name
2	VCC
7	HDDLED

---

➤ **Power-On LED**

This connector allows users to connect to Front Panel Power indicator.

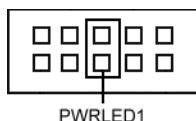

<b>PWR LED Pin #</b>	<b>Signal Name</b>
3	VCC
8	GND

➤ **RESET Switch**

The reset switch allows the user to reset the system without turning the main power switch off and then on. Orientation is not required when making a connection to this header.

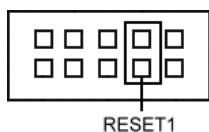

<b>RESET Pin #</b>	<b>Signal Name</b>
4	Reset
9	GND

➤ **KEYLOCK Switch**

The keylock switch, when closed, will disable the keyboard function.

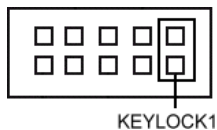

<b>RESET Pin #</b>	<b>Signal Name</b>
5	KEYLOCK
10	GND

---

## BACKLIGHT Connector

---

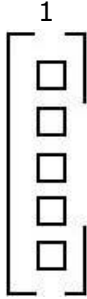

Pin #	Signal Name
1	+12V
2	GND
3	Brightness
4	ON/OFF
5	GND

---

## TV-OUT Connector

---

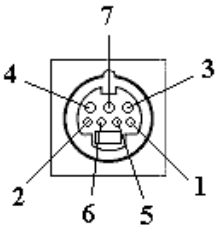

Pin #	Signal Name
1	GND
2	GND
3	LUMA
4	CHOMA
5	CVBS
6	GND
7	NC

---

## IRDA Connector

---

This connector is used for an IRDA connector for wireless communication.

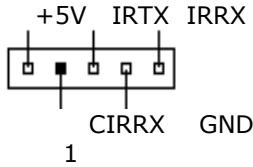

IrDA Pin #	Signal Name
1	+5V
2	FIR
3	IR-RX
4	GND
5	IR-TX

## IDE Connectors

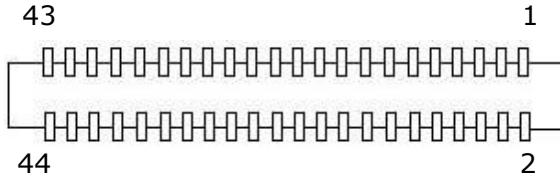

### Primary IDE Connector

Signal Name	Pin #	Pin #	Signal Name
Reset IDE	1	2	Ground
Host data 7	3	4	Host data 8
Host data 6	5	6	Host data 9
Host data 5	7	8	Host data 10
Host data 4	9	10	Host data 11
Host data 3	11	12	Host data 12
Host data 2	13	14	Host data 13
Host data 1	15	16	Host data 14
Host data 0	17	18	Host data 15
Ground	19	20	Key
DRQ	21	22	Ground
Host IOW	23	24	Ground
Host IOR	25	26	Ground
IOCHRDY	27	28	Host PU 0
DACK	29	30	Ground
IRQ14	31	32	No connect
Address 1	33	34	P66DET
Address 0	35	36	Address 2
Chip select 1	37	38	Chip select 3
Activity LED	39	40	GND
VCC	41	42	VCC
GND	43	44	NC

---

## COM1 Serial Ports

---

COM1, a 9-pin D-Sub male connector, is the onboard COM1 serial port of the TR-LCD1500-ITX SBC. The following table shows its pin assignments.

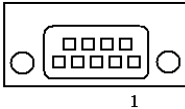

Pin #	Signal Name
1	DCD, Data carrier detect
2	RXD, Receive data
3	TXD, Transmit data
4	DTR, Data terminal ready
5	GND, ground
6	DSR, Data set ready
7	RTS, Request to send
8	CTS, Clear to send
9	+5V, Ring-IN or +12V

## COM2 Serial Ports

---

COM2, a 9-pin D-Sub male connector, is the onboard COM2 serial port of the TR-LCD1500-ITX SBC. The following table shows its pin assignments.

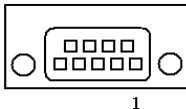

Pin #	RS232 Mode Signal Name	RS422/RS485 Mode Signal Name
1	DCD, Data carrier detect	TX- (422/485)
2	RXD, Receive data	TX+ (422/485)
3	TXD, Transmit data	RX+ (422)
4	DTR, Data terminal ready	RX- (422)
5	GND, ground	GND
6	DSR, Data set ready	N.C.
7	RTS, Request to send	N.C.
8	CTS, Clear to send	N.C.
9	+5V, Ring-IN or +12V	N.C.

---

## COM3, COM4, COM5 Serial Ports

---

COM3, COM4, COM5 a 10-pin header connector, is the onboard COM3, COM4, COM5 serial port of the TR-LCD1500-ITX SBC. The following table shows its pin assignments.

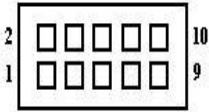

#	
1	DCD, Data carrier detect
2	RXD, Receive data
3	TXD, Transmit data
4	DTR, Data terminal ready
5	GND, ground
6	DSR, Data set ready
7	RTS, Request to send
8	CTS, Clear to send
9	Ring-IN
10	NC

---

## COM6 Serial Ports

---

COM6, a 10-pin header connector, is the onboard COM6 serial port of the TR-LCD1500-ITX SBC. The following table shows its pin assignments.

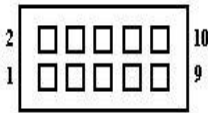

Pin #	RS232 Mode Signal Name
1	DCD, Data carrier detect
2	RXD, Receive data
3	TXD, Transmit data
4	DTR, Data terminal ready
5	GND, ground
6	DSR, Data set ready
7	RTS, Request to send
8	CTS, Clear to send
9	+5V, +12V
10	NC

Pin9 is power pin to support devices required power. The voltage can be selected by jumper JP8.

## LPT Port

The LPT parallel port is a standard DSUB 25-pins Female connector. It can be configured as EPP or ECP or SPP mode.

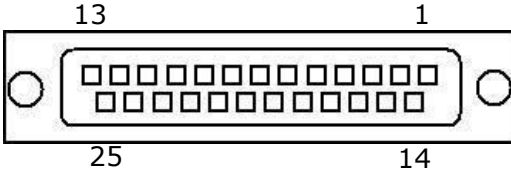

Signal Name	Pin #	Pin #	Signal Name
Strobe	1	14	AUTOFD
DATA0	2	15	ERROR
DATA1	3	16	INIT
DATA2	4	17	SLIN
DATA3	5	18	GND
DATA4	6	19	GND
DATA5	7	20	GND
DATA6	8	21	GND
DATA7	9	22	GND
ACK	10	23	GND
BUSY	11	24	GND
PE	12	25	GND
SLCT	13		

## PS/2 Keyboard & Mouse Connector

The following table describes the pin assignment of PS/2 Keyboard and Mouse connector.

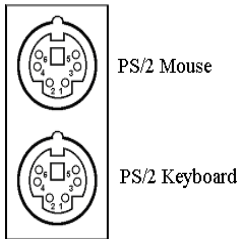

Pin #	Signal Name
1	Keyboard/Mouse data
2	NC
3	GND
4	5V
5	Keyboard/Mouse clock
6	GND

## VGA Connector

The pin assignments of VGA CRT connector are as follows:

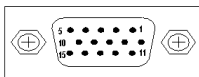

Signal Name	Pin #	Pin #	Signal Name
Red	1	2	Green
Blue	3	4	N.C.
GND	5	6	GND
GND	7	8	GND
N.C.	9	10	GND
N.C.	11	12	DDC_DATA
HSYNC	13	14	VSYNC
DDC_CLK	15		

---

## INT\_VGA Connector

---

INT\_VGA is for internal Video A/D board connection. The pin out is listed as below:

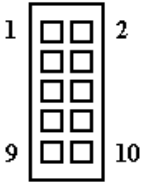

Signal Name	Pin #	Pin #	Signal Name
RED	1	2	GND
GREEN	3	4	GND
BLUE	5	6	GND
HSYNC	7	8	DDC_DATA
VSYNC	9	10	DDC_CLK

## INT\_KBMS Connector

---

KBMS is for internal input devices or MSR connection. The pin out is listed as below:

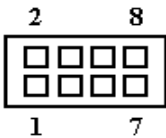

Signal Name	Pin #	Pin #	Signal Name
VCC	1	2	GND
KBDAT	3	4	MSCLK
KBCLK	5	6	MSDAT
GND	7	8	VCC

---

## DC\_IN1 Connector

---

DC\_IN1 is for external power input connection to supply system power. It needs to be +12V input from AC/DC adapter within 5% tolerance.

Users should calculate the total system power required and use sufficient rating adapter.

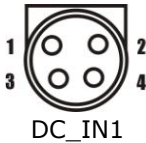

Signal Name	Pin #	Pin #	Signal Name
+12V	1	2	+12V
GND	3	4	GND

---

## DC\_IN2 Power Connector

---

The CD\_IN2 power connector is for internal connection to +12V input power. If you already have external +12V power input connected on DC\_IN1, please leave DC\_IN2 unconnected.

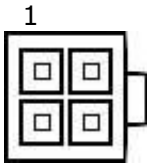

Pin #	Signal Name
1	GND
2	GND
3	+12V
4	+12V

---

## CPU Fan Power Connector

---

This is a 3-pin header for the CPU fan.



Pin #	Signal Name
1	Ground
2	+12V
3	CPUPWM

## System FAN Power Connector

This is a 3-pin header for the system fan.

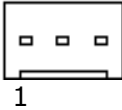

Pin #	Signal Name
1	Ground
2	+12V
3	SYSPWM

## DRV PWR Connector

DRV PWR is output power connector to supply power required for peripheral device like Hard Disk, DOM, CDROM and etc.

The pin out is listed as below:



Signal Name	Pin #	Pin #	Signal Name
+5V	1	2	GND
GND	3	4	+12V

## USB56 USB78 Connectors

The following table shows the pin outs of the USB56 USB78 connectors.

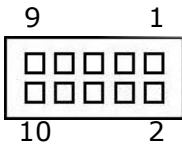

USB5,USB6 USB7,USB8 Pin#		Signal Name
10	1	N.C.
2	9	+5V
8	3	Ground
4	7	USB-
6	5	USB+

---

## LANGbE+USBx2 Connectors

---

Below pictures show the location of LAN GbE ports and USB Type-A ports on the Combo GbE + USB connector.

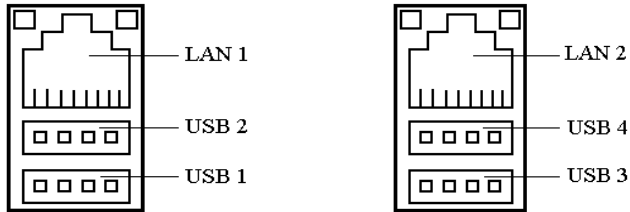

Before you connect your device(s) into USB connector(s), please make sure your device(s) such as USB keyboard, mouse, scanner, zip, speaker and etc., Have a standard USB interface. Also make sure your OS supports USB controller.

If your OS does not support USB controller, please contact OS vendor for possible patch or driver upgrade. For more information please contact your OS or device(s) vendors.

---

## LAN- GBE Connectors

---

This connector is for the 10/100/1000Mbps Ethernet capability. The figure below shows the pin out assignments of this connector and its corresponding input jack.

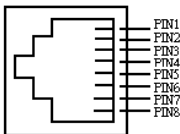

Pin #	Signal Name
1	MDI0+
2	MDI0-
3	MDI1+
4	MDI1-
5	MDI2+
6	MDI2-
7	MDI3+
8	MDI3-

---

## LAN RJ45 LED1, 2

---

The LAN\_LEDs on top of RJ45 are to display the current network connection status. The green color LED on the right-hand side shows the link status and TX/RX activity. The Orange/Green Dual color LED on the left-hand side indicates the operation mode, i.e. 10Base-T, 100Base-T or 1000Base-T.

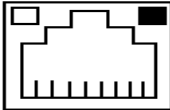

<b>LNK/ACT</b>	<b>STATUS</b>
YELLOW	Link
OFF	Disconnected
FLASH	Packets TX/RX

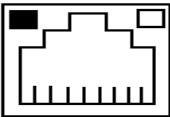

<b>SPEED</b>	<b>MODE</b>
ORANGE	1000 Mbps
GREEN	100 Mbps
OFF	10 Mbps

---

## Audio Connectors

---

After install onboard audio driver, you may connect speaker to Line Out jack, microphone to MIC In jack.

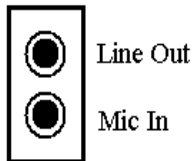

---

## INT\_AUDIO Connector

---

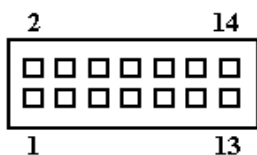

Pin #	Signal Name
1	LINE-IN-L
2	LINE-IN-R
3	GND
4	GND
5	LINEOUT-L
6	LINEOUT-R
7	GND
8	GND
9	MIC1-IN-L
10	MIC1-IN-R
11	LFE OUT
12	CENTER OUT
13	SURR OUTL
14	SURR OUTR

## LVDS LCD Connector

The LCD panel, inverter for LCD LAMP, Touch-screen Serial Interface must be connected to this LVDS header, using the below described connector:

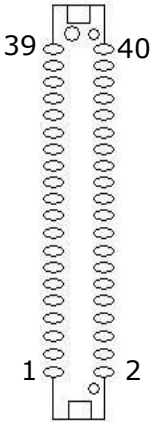

Signal Name	Pin #	Pin #	Signal Name
+12V	2	1	+12V
GND	4	3	GND
LCDVDD 5V/3.3V	6	5	LCDVDD 5V/3.3V
GND	8	7	GND
BCKLITE_ON	10	9	BRIGHTNES
LVDS_GND	12	11	LVDS_GND
CHB_TX0+	14	13	CHA_TX0+
CHB_TX0-	16	15	CHA_TX0-
LVDS_GND	18	17	LVDS_GND
CHB_TX1+	20	19	CHA_TX1+
CHB_TX1-	22	21	CHA_TX1-
LVDS_GND	24	23	LVDS_GND
CHB_TX2+	26	25	CHA_TX2+
CHB_TX2-	28	27	CHA_TX2-
LVDS_GND	30	29	LVDS_GND
CHB_TXC+	32	31	CHA_TXC+
CHB_TXC-	34	33	CHA_TXC-
LVDS_GND	36	35	LVDS_GND
CHB_TX3+	38	37	CHA_TX3+
CHB_TX3-	40	39	CHA_TX3-

---

## DIO Connector

---

DIO port supports 8 digital I/O bits. Each bit can be configured as Input or output individually. All bits are 5V tolerant.

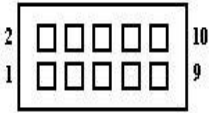

Signal Name	Pin #	Pin #	Signal Name
GND	1	2	+5V
DIO_0	3	4	DIO_4
DIO_1	5	6	DIO_5
DIO_2	7	8	DIO_6
DIO_3	9	10	DIO_7

---

## SATA1, SATA2 Connectors

---

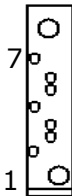

Pin #	Signal Name
1	GND
2	SATATX+
3	SATATX-
4	GND
5	SATARX-
6	SATARX+
7	GND

## CF-II Connector

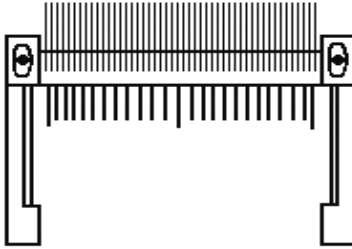

Signal Name	Pin #	Pin #	Signal Name
GND	1	2	PDD3
PDD4	3	4	PDD5
PDD6	5	6	PDD7
PCS1-	7	8	GND
GND	9	10	GND
GND	11	12	GND
VCC	13	14	GND
GND	15	16	GND
GND	17	18	PDA2
PDA1	19	20	PDA0
PDD0	21	22	PDD1
PDD2	23	24	N.C.
N.C.	25	26	N.C.
PDD11	27	28	PDD12
PDD13	29	30	PDD14
PDD15	31	32	PCS3-
N.C.	33	34	PDIOR-
PDIOW-	35	36	VCC
IRQ14	37	38	VCC
MST#_SLV	39	40	N.C.
PST1-	41	42	PIORDY
PDDREQ	43	44	PDDACK-
CF_LED-	45	46	N.C.
PDD8	47	48	PDD9
PDD10	49	50	GND

# 3

---

## BIOS Setup

This chapter describes the different settings available in the Award BIOS that comes with the TR-LCD1500-ITX. The topics covered in this chapter are as follows:

Main Menu .....	39-45
Standard CMOS Features .....	46-50
Advanced BIOS Features .....	51-57
Advanced Chipset Features .....	58-62
Integrated Peripherals .....	63-79
Power Management Setup .....	80-85
PnP/PCI Configurations .....	86-89
PC Health Status .....	90-91
Frequency/Voltage Control .....	92
Load Fail-Safe Defaults .....	92
Load Optimized Defaults .....	93
Set Supervisor/User Password .....	93-95
Save & Exit Setup .....	95
Exit Without Saving .....	96

---

## **BIOS Introduction**

---

This Chapter discusses Award™ Setup program built into the TR-LCD1500-ITX BIOS. The Setup program allows users to modify the basic system configuration. This special information is then stored in battery-backed RAM so that it retains the Setup information when the power is turned off.

The AwardBIOS™ installed in TR-LCD1500-ITX is a custom version of an industry standard BIOS.

This means that it supports Intel Core 2 Duo in a standard IBM-AT compatible input/output system. The BIOS provides critical low-level support for standard devices such as disk drives and serial and parallel ports.

It also adds non-standard, features such as virus and password protection as well as special support for detailed fine-tuning of the chipset controlling the entire system.

The rest of this chapter is intended to guide you through the process of configuring your system using Setup.

---

## **Starting Setup**

---

The AwardBIOS™ is immediately activated when you first power on the computer. The BIOS reads the system information contained in the CMOS and begins the process of checking out the system and configuring it. When it finishes, the BIOS will seek an operating system on one of the disks and then launch and turn control over to the operating system.

While the BIOS is in control, the Setup program can be activated in one of two ways:

1. By pressing <Del> immediately after switching the system on, or
2. by pressing the <Del> key when the following message appears briefly at the bottom of the screen during the POST (Power On Self-Test).

---

**Press DEL to enter SETUP.**

If the message disappears before you respond and you still wish to enter Setup, restart the system to try again by turning it OFF then ON or pressing the "RESET" button on the system case. You may also restart by simultaneously pressing <Ctrl>, <Alt>, and <Delete> keys. If you do not press the keys at the correct time and the system does not boot, an error message will be displayed and you will again be asked to...

**PRESS F1 TO CONTINUE, DEL TO ENTER SETUP****Using Setup**

---

In general, you use the arrow keys to highlight items, press <Enter> to select, use the PageUp and PageDown keys to change entries, press <F1> for help and press <Esc> to quit. The following table provides more detail about how to navigate in the Setup program using the keyboard.

Key	Function
Up Arrow	Move to the previous item
Down Arrow	Move to the next item
Left Arrow	Move to the item on the left (menu bar)
Right Arrow	Move to the item on the right (menu bar)
Esc	Main Menu: Quit without saving changes Submenus: Exit Current page to the next higher level menu
Move Enter	Move to the item you desired
PgUp key	Increase the numeric value or make changes
PgDn key	Decrease the numeric value or make changes
+ key	Increase the numeric value or make changes
- key	Decrease the numeric value or make changes
Esc key	Main Menu -- Quit and not save changes into CMOS Status Page Setup Menu and Option Page Setup Menu -- Exit current page and return to Main Menu
F1 key	General help on Setup navigation keys
F5 key	Load previous values from CMOS
F6 key	Load the fail-safe defaults from BIOS default table
F7 key	Load the optimized defaults
F10 key	Save all the CMOS changes and exit

### **Navigating through the menu bar**

Use the left and right arrow keys to choose the menu you want to be in.

### **To display a sub menu**

Use the arrow keys to move the cursor to the sub menu you want. Then press <Enter>. A ">" pointer marks all sub menus.

---

## **Getting Help**

---

Press F1 to pop up a small help window that describes the appropriate keys to use and the possible selections for the highlighted item. To exit the Help Window press <Esc> or the F1 key again.

## **In Case of Problems**

---

If, after making and saving system changes with Setup, you discover that your computer no longer is able to boot, the AwardBIOS™ supports an override to the CMOS settings which resets your system to its defaults. The best advice is to only alter settings that you thoroughly understand. To this end, we strongly recommend that you avoid making any changes to the chipset defaults. These defaults have been carefully chosen by both Award and TR-LCD1500-ITX manufacturer to provide the absolute maximum performance and reliability. Even a seemingly small change to the chipset setup has the potential for causing you to use the override.



---

## ➤ **Advance Chipset Features**

---

Use this menu to change the values in the chipset registers and optimize your system's performance.

## ➤ **Integrated Peripherals**

---

Use this menu to specify your settings for integrated peripherals.

## ➤ **Power Management Setup**

---

Use this menu to specify your settings for power management.

## ➤ **PnP/PCI Configurations**

---

Use this menu to set up the PnP/PCI configuration.

## ➤ **PC Health Status**

---

Use this menu to display the CPU temperature, FAN speed and voltages.

## ➤ **Frequency/Voltage Control**

---

Use this menu to specify your settings for frequency/voltage control.

## ➤ **Load Fail-Safe Defaults**

---

Use this menu to load the BIOS default values for the minimal/stable performance for your system to operate.

## ➤ **Load Optimized Defaults**

---

Use this menu to load the BIOS default values that are factory settings for optimal performance system operations. While Award has designed the custom BIOS to maximize performance, the factory has the right to change these defaults to meet their needs.

## ➤ **Set Supervisor/ User Password**

---

Use this menu to set User and Supervisor Passwords.

---

➤ **Save & Exit Setup**

---

Save CMOS value changes to CMOS and exit setup.

➤ **Exit Without Saving**

---

Abandon all CMOS value changes and exit setup.

## 3.2 Standard CMOS Features

The items in Standard CMOS Setup Menu are divided into 10 categories. Each category includes no, one or more than one setup items. Use the arrow keys to highlight the item and then use the <PgUp> or <Pg Dn> keys to select the value you want in each item.

Phoenix-Award BIOS CMOS Setup Utility Standard CMOS Features		
Date (mm :dd: yy)	Mon, Apr 28 2008	Item Help  Menu Level ►  Change the day, month, year, and century
Time (hh: mm: ss)	15 : 35 : 35	
▶ IDE Channel 0 Master	[None]	
▶ IDE Channel 0 Slave	[None]	
▶ IDE Channel 1 Master	[None]	
▶ IDE Channel 1 Slave	[None]	
Drive A	[None]	
Drive B	[None]	
Video	[EGA/VGA]	
Halt On	[All , But Disk/Key]	
Base Memory	639K	
Extend Memory	1038336K	
Total Memory	1039360K	
↑ ↓ ← → : Move    Enter: Select    +/-/PU/PD: Value    F10:Save    Esc: Exit    F1:General Help F5:Previous Value    F6:Fail-Safe Defaults    F7:Optimized Default		

(Figure 2)

This table shows the selections that you can make on the Standard CMOS Menu

<b>Item</b>	<b>Options</b>	<b>Description</b>
Date	Month DD YYYY	Set the system date. Note that the 'Day' automatically changes when you set the date
Time	HH : MM : SS	Set the system time
IDE Channel 0 Master	Options are in its sub menu	Press <Enter> to enter the sub menu of detailed options
IDE Channel 0 Slave	Options are in its sub menu	Press <Enter> to enter the sub menu of detailed options
IDE Channel 1 Master	Options are in its sub menu	Press <Enter> to enter the sub menu of detailed options
IDE Channel 1 Slave	Options are in its sub menu	Press <Enter> to enter the sub menu of detailed options
Drive A Drive B	None 360K, 5.25 in 1.2M, 5.25 in 720K, 3.5 in 1.44M, 3.5 in 2.88M, 3.5 in	Select the type of floppy disk drive installed in your system
Video	EGA/VGA CGA 40 CGA 80 MONO	Select the default video device
Halt On	All Errors No Errors All, but Keyboard All, but Diskette All, but Disk/Key	Select the situation in which you want the BIOS to stop the POST process and notify you
Base Memory	N/A	Displays the amount of conventional memory detected during boot up
Extended Memory	N/A	Displays the amount of extended memory detected during boot up
Total Memory	N/A	Displays the total memory available in the system

---

## IDE Channel 0, 1 Master/ Slave

---

The IDE adapters control the hard disk drive. Use a separate sub menu to configure each hard disk drive. Figure 3 shows the IDE Channel 0 / Channel 1 master sub menu.

Phoenix-Award BIOS CMOS Setup Utility IDE Channel 0 Master		
IDE HDD Auto-Detection	[Press Enter]	Item Help Menu Level ►
IDE Channel 0 Master Access Mode	[Auto] [Auto]	To auto-detect the HDD's size, head...on this channel
Capacity	0 MB	
Cylinder	0	
Head	0	
Precomp	0	
Landing Zone	0	
Sector	0	
↑↓←→ : Move    Enter: Select    +/-/PU/PD: Value    F10:Save    Esc: Exit    F1:General Help F5:Previous Value    F6:Fail-Safe Defaults    F7:Optimized Default		

**(Figure 3)**

Use the legend keys to navigate through this menu and exit to the main menu. Use the Table listed below to configure the hard disk.

Item	Options	Description
IDE HDD Auto-detection	Press Enter	Press Enter to auto-detect the HDD on this channel. If detection is successful, it fills the remaining fields on this menu.
IDE Channel 0 Master	None Auto Manual	Selecting 'manual' lets you set the remaining fields on this screen. Selects the type of fixed disk. "User Type" will let you select the number of cylinders, heads, etc. Note: PRECOMP=65535 means NONE !
Access Mode	CHS LBA Large Auto	Choose the access mode for this hard disk
Capacity	Auto Display your disk drive size	Disk drive capacity (Approximated). Note that this size is usually slightly greater than the size of a formatted disk given by a disk checking program.
The following options are selectable only if the 'IDE Channel 0 Master' item is set to 'Manual'		
Cylinder	Min = 0 Max = 65535	Set the number of cylinders for this hard disk.
Head	Min = 0 Max = 255	Set the number of read/write heads
Precomp	Min = 0 Max = 65535	**** Warning: Setting a value of 65535 means no hard disk
Landing zone	Min = 0 Max = 65535	****
Sector	Min = 0 Max = 255	Number of sectors per track

---

## Drive A/B

---

These fields identify the types of floppy disk drive A or drive B that has been installed in the computer. The available specifications are:

None(**default**) 360K 1.2M 720K 1.44M 2.88M  
5.25 in. 5.25 in. 3.5 in. 3.5 in. 3.5 in.

---

## Video

---

This field selects the type of video display card installed in your system. You can choose the following video display cards:

EGA/VGA: For EGA, VGA, SEGA, SVGA or PGA monitor adapters. (**default**)

CGA 40: Power up in 40 column mode.

CGA 80: Power up in 80 column mode.

MONO: For Hercules or MDA adapters.

---

## Halt On

---

This field determines whether the system will halt if an error is detected during power up.

All errors	Whenever the BIOS detects a non-fatal error, the system will stop and you will be prompted.
No errors	The system boot will not be halted for any error that may be detected.
All, But Keyboard	The system boot will not be halted for a keyboard error; it will stop for all other errors
All, But Diskette	The system boot will not be halted for a disk error; it will stop for all other errors.
All, But Disk/Key	The system boot will not be halted for a key- board or disk error; it will stop for all others. ( <b>default</b> )

### 3.3 Advanced BIOS Features

This section allows you to configure your system for basic operation. You have the opportunity to select the system's default speed, boot-up sequence, keyboard operation, shadowing and security.

Phoenix-Award BIOS CMOS Setup Utility Advanced BIOS Features		
▶ CPU Features	[Press Enter]	Item Help
▶ Hard Disk Boot Priority	[Press Enter]	Menu Level ▶
Virus Warning	[Disabled]	
CPU L1 & L2 Cache	[Enabled]	
CPU L3 Cache	[Enabled]	
Quick Power On Self Test	[Enabled]	
First Boot Device	[Hard Disk]	
Second Boot Device	[CDROM]	
Third Boot Device	[LS120]	
Boot Other Device	[Enabled]	
Swap Floppy Drive	[Disabled]	
Boot Up Floppy Seek	[Enabled]	
Boot UP Num Lock Status	[Off]	
Gate A20 Option	[Fast]	
Typematic Rate Setting	[Disabled]	
x Typematic Rate (Chars/Sec)	6	
x Typematic Delay (Msec)	250	
Security Option	[Setup]	
x APIC Mode	Enabled	
MPS Version Control For OS	[1.4]	
OS Select For DRAM > 64MB	[Non-OS2]	
Report No FDD For WIN 95	[No]	
↑ ↓ ← → : Move    Enter: Select    +/-/PU/PD: Value    F10:Save    Esc: Exit    F1:General Help F5:Previous Value    F6:Fail-Safe Defaults    F7:Optimized Default		

(Figure 4)

---

## ➤CPU Feature

---

Phoenix-Award BIOS CMOS Setup Utility CPU Feature		
Delay Prior to Thermal	[16 Min]	Item Help  Menu Level ▶
Limit CPUID MaxVal	[Disabled]	
C1E Function	[Auto]	
Execute Disabled Bit	[Enabled]	
↑↓←→ : Move Enter: Select +/-/PU/PD: Value F10:Save Esc: Exit F1:General Help F5:Previous Value F6:Fail-Safe Defaults F7:Optimized Default		

**(Figure 5)**

### **Delay Prior to Thermal**

Delay Prior To Thermal is set at 16 minutes as default, which means the board will wait 16 minutes before it activates the processor's integrated thermal control circuit.

The choice: 4 Min , 8 Min, 16 Min (**default**), 32 Min.

### **Limit CPUID Max Val**

The choice: Enabled, Disabled (**default**).

### **C1E Function**

The choice: Auto (**default**), Disabled

### **Execute Disabled Bit**

The choice: Enabled (**default**), Disabled

---

## ➤Hard Disk Boot Priority

---

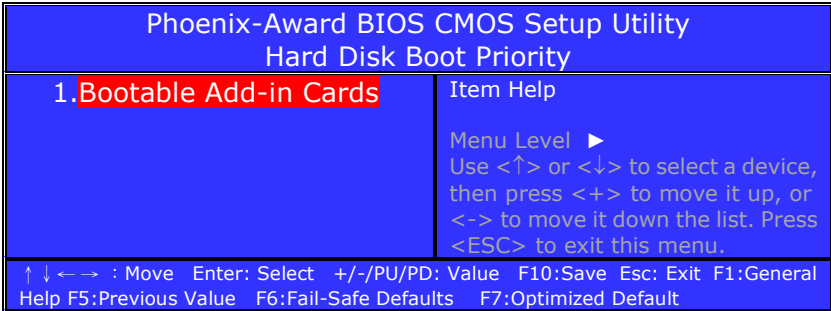

**(Figure 6)**

### **Bootable Add-in Cards**

This is for setting the priority of the hard disk boot order when the "Hard Disk" option is selected in the "[First/Second/Third] Boot Device" menu item.

---

## Virus Warning

---

Allows you to choose the VIRUS Warning feature for IDE Hard Disk boot sector protection.

If this function is enabled and someone attempt to write data into this area, BIOS will show a warning message on screen and alarm beep.

Enabled	Activates automatically when the system boots up causing a warning message to appear when anything attempts to access the boot sector or hard disk partition table.
Disabled	No warning message will appear when anything attempts to access the boot sector or hard disk partition table. <b>(default)</b>

---

## CPU L1 & L2 Cache

---

These two categories speed up memory access. However, it depends on CPU/chipset design.

Enabled	Enable cache <b>(default)</b>
Disabled	Disable cache

---

## CPU L3 Cache

---

This field is used to enable or disable the CPU's L3 cache. The choice: Enabled **(default)**, Disabled.

---

## Quick Power On Self Test

---

Allows the system to skip certain tests while booting. This will decrease the time needed to boot the system.

Enabled	Enable quick POST <b>(default)</b>
Disabled	Normal POST

---

## First/Second/Third Boot Device

---

The BIOS attempts to load the operating system from the devices in the sequence selected in these items. The Choice: Floppy, LS120, Hard-Disk, ZIP100, CDROM, Disabled, USB-FDD, USB-ZIP, USB-CDROM, Legacy LAN.

Item	Default
First Boot Device	Hard-Disk
Second Boot Device	CDROM
Third Boot Device	LS120

---

## Boot Other Device

---

When enabled, BIOS will try to load the operating system from other device when it failed to load from the three devices above.

The choice: Enabled (**default**), Disabled.

---

## Swap Floppy Drive

---

If the system has two floppy drives, choose "Enabled" to assign physical drive B to logical drive A and vice-versa. The choice: Enabled, Disabled (**default**).

---

## Boot Up Floppy Seek

---

Selection of the command .Disabled. will speed the boot up. Selection of .Enabled. Searches disk drives during boot up.

The choice: Enabled (**default**), Disabled

---

## Boot Up Num Lock Status

---

Selects power on state for Num Lock.

The choice: On, Off (**default**).

---

## Gate A20 Option

---

The choice:

Normal: A pin in the keyboard controller controls GateA20.

Fast (**default**): Lets chipset control GateA20.

---

## Typematic Rate Setting

---

Keystrokes repeat at a rate determined by the keyboard controller. When enabled, the typematic rate and typematic delay can be selected.

The choice: Enabled, Disabled (**default**).

**If Typematic Rate Setting is [Enabled]  
can choice Rate and Delay:**

## Typematic Rate (Chars/Sec)

---

Sets the number of times a second to repeat a keystroke when you hold the key down.

The choice: 6 (**default**), 8, 10, 12, 15, 20, 24, 30

Typematic Rate (Chars/Sec)	
6	..... [ █ ]
8	..... [ ]
10	..... [ ]
12	..... [ ]
15	..... [ ]
20	..... [ ]
24	..... [ ]
30	..... [ ]
↑↓: Move Enter: Accept ESC:Abort	

## Typematic Delay (Msec)

---

Sets the delay time after the key is held down before it begins to repeat the keystroke.

The choice: 250 (**default**), 500, 750, and 1000.

Typematic Delay (Msec)	
250	..... [ █ ]
500	..... [ ]
750	..... [ ]
1000	..... [ ]
↑↓: Move Enter: Accept ESC:	

---

## Security Option

---

Select whether the password is required every time the system boots or only when you enter setup.

System	The system will not boot and access to Setup will be denied if the correct password is not entered at the prompt.
Setup	The system will boot, but access to Setup will be denied if the correct password is not entered at the prompt. <b>(default)</b>

Note: To disable security, select PASSWORD SETTING at Main Menu and then you will be asked to enter password. Do not type anything and just press <Enter>, it will disable security. Once the security is disabled, the system will boot and you can enter Setup freely.

---

## APIC Mode

---

This setting allows to enable the APIC mode.  
The choice: Enabled **(default)**, Disabled

---

## MPS Version Control For OS

---

The BIOS supports version 1.1 and 1.4 of the Intel multiprocessor specification.  
Select version supported by the operation system running on this computer.  
The choice: 1.1, 1.4 **(default)**.

---

## OS Select For DRAM > 64MB

---

Select OS2 only if you are running OS/2 operating system with greater than 64MB of RAM on the system.  
The choice: Non-OS2 **(default)**, OS2.

---

## Report No FDD For WIN 95

---

The choice: No **(default)**, Yes.

### 3.4 Advanced Chipset Features

This section allows you to configure the system based on the specific features of the installed chipset. This chipset manages bus speeds and access to system memory resources, such as DRAM and the external cache. It also coordinates communications between the conventional ISA bus and the PCI bus. It must be stated that these items should never need to be altered. The default settings have been chosen because they provide the best operating conditions for your system. The only time you might consider making any changes would be if you discovered that data was being lost while using your system.

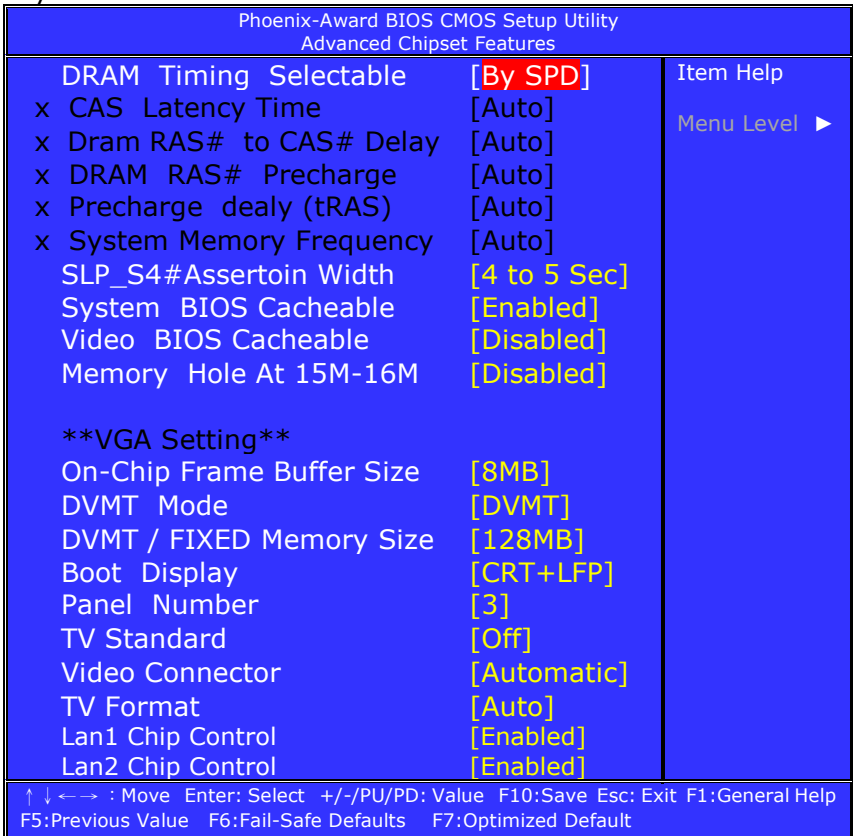

(Figure 7)

---

## DRAM Timing Selectable

---

The choice: Manual, By SPD (**default**).

**If DRAM Timing Selectable is [Manual], can choice these Items:**

- ▶ CAS Latency Time
- ▶ Dram RAS# to CAS# Delay
- ▶ DRAM RAS# Precharge
- ▶ Precharge dealy (tRAS)
- ▶ System Memory Frequency

---

## CAS Latency Time

---

This controls the latency between DDR RAM read command and the time that the data actually becomes available.

Leave this on the default setting.

The choice: 5, 4, 3, 6, Auto (**default**).

---

## DRAM RAS# to CAS# Delay

---

In order to improve performance, certain space in memory is reserved for PISA cards.

This memory must be mapped into the memory space below 16MB.

The choice: 2, 3, 4, 5, 6, Auto (**default**).

---

## DRAM RAS# Precharge

---

This controls the idle clocks after issuing a precharge command to DRAM.

Leave this on the default setting.

The choice: Auto (**default**), 2, 3,4,5,6.

---

## Precharge dealy (tRAS)

---

The choice: Auto (**default**),  
4,5,6,7,8,9,10,11,12,13,14,15.

---

## System Memory Frequency

---

The choice: Auto (**default**), 533MHz, 667MHz

---

## **SLP\_S4#Assertoin Width**

---

Set SLP\_S4# pin.

The choice: 4 to5 Sec (**default**), 3 to 4Sec, 2to 3Sec, 1to2Sec.

---

## **System BIOS Cacheable**

---

Selecting the "Enabled" option allows caching of the system BIOS ROM at F0000h-FFFFFh, which is able to improve the system performance. However, any programs that attempts to write to this memory block will cause conflicts and result in system errors.

The choice: Enabled (**default**), Disabled.

---

## **Video BIOS Cacheable**

---

Selecting Enabled allows caching of the video BIOS, resulting in better system performance. However, if any program writes to this memory area, a system error may occur.

The choice: Enabled, Disabled (**default**)

---

## **Memory Hole At 15M-16M**

---

Enabling this feature reserves 15 MB to 16 MB memory address space for ISA expansion cards that specifically require this setting. This makes memory from 15 MB and up unavailable to the system. Expansion cards can only access memory up to 16 MB.

The choice: Enabled, Disabled (**default**)

---

## **On-Chip Frame Buffer Size**

---

User can select frame buffer size.

The choice: 1MB, 8MB (**default**).

---

## **DVMT Mode**

---

This field shows the current DVMT mode.

The choice: FIXED, DVMT (**default**), BOTH

---

## DVMT / FIXED Memory Size

---

This field is used to select the graphics memory size used by DVMT/ Fixed mode.

The choice: 64MB, 128MB (**default**), 224MB

## Boot Display

---

This field is used to select the type of display to use when the system boots.

The choice:

Auto	CRT	TV	EFP
LFP	CRT+LFP <b>(default)</b>	EFP+LFP	

## Panel Number

---

The choice: 1,2,3

**(default)**,4,5,6,7,8,9,10,11,12,13,14,15,16

## TV Standard

---

The choice: Off (**default**), NTSC, PAL, SECAM.

## Video Connector

---

The choice: Automatic (**default**), Composite, Component, Both.

## TV Format

---

The choice:

Auto( <b>default</b> )	NTSC_M	NTSC_M_J
NTSC_433	NTSC_N	PAL_B
PAL_G	PAL_D	PAL_H
PAL_I	PAL_M	PAL_N
PAL_60	SECAM_L	SECAM_L1
SECAN_B	SECAN_D	SECAN_G
SECAN_H	SECAN_K	SECAN_K1

---

## **Lan1 Chip Control**

---

The choice: Enabled (**default**), Disabled.

## **Lan2 Chip Control**

---

The choice: Enabled (**default**), Disabled.

---

## 3.5 Integrated Peripherals

Phoenix-Award BIOS CMOS Setup Utility Integrated Peripherals		
▶ On Chip IDE Device	[Press Enter]	Item Help
▶ Onboard Device	[Press Enter]	
▶ Super IO Device	[Press Enter]	Menu Level ▶
Onboard Serial Port 3	[3E8]	
Serial Port 3 Use IRQ	[IRQ3]	
Onboard Serial Port 4	[2E8]	
Serial Port 4 Use IRQ	[IRQ4]	
Onboard Serial Port 5	[4F8]	
Serial Port 5 Use IRQ	[IRQ5]	
Onboard Serial Port 6	[4E8]	
Serial Port 6 Use IRQ	[IRQ7]	
Watch Dog Timer Select	[Disabled]	
↑ ↓ ← → : Move Enter: Select +/-/PU/PD: Value F10:Save Esc: Exit F1:General Help F5:Previous Value F6:Fail-Safe Defaults F7:Optimized Default		

**(Figure 8)**

## ➤ On Chip IDE Device

Phoenix-Award BIOS CMOS Setup Utility On Chip IDE Device		
IDE HDD Block Mode	[Enabled]	Item Help
On-Chip Primary PCI IDE	[Enabled]	Menu Level ▶
IDE Primary Master PIO	[Auto]	If your IDE hard drive supports block mode select Enabled for automatic detection of the optimal number of block read/write s per sector the drive can support
IDE Primary Slave PIO	[Auto]	
IDE Primary Master UDMA	[Auto]	
IDE Primary Slave UDMA	[Auto]	
On-Chip Secondary PCI IDE	[Enabled]	
IDE Secondary Master PIO	[Auto]	
IDE Secondary Slave PIO	[Auto]	
IDE Secondary Master UDMA	[Auto]	
IDE Secondary Slave UDMA	[Auto]	
*** On-Chip Serial ATA Setting***		
x SATA Mode	IDE	
On-Chip Serial ATA	[Auto]	
x SATA PORT Speed Settings	Disable	
x PATA IDE Mode	Secondary	
x SATA Port	PO, P2 is Primary	
↑ ↓ ← → : Move Enter: Select +/-/PU/PD: Value F10:Save Esc: Exit F1:General Help F5:Previous Value F6:Fail-Safe Defaults F7:Optimized Default		

(Figure 9)

### IDE HDD Block Mode

Block mode is also called block transfer, multiple commands, or multiple sectors read / write.

If your IDE hard drive supports block mode (most new drives do), select Enabled for automatic detection of the optimal number of block mode (most new drives do), select

Enabled for automatic detection of the optimal number of block read /write per sector where the drive can support. The choice: Enabled (**default**), Disabled

---

## On-Chip Primary PCI IDE

---

This field allows you to enable or disable the primary and secondary IDE controller.

Select disabled if you want to add a different hard drive controller.

The choice: Enabled (**default**), Disabled

## IDE Primary/Secondary, Master/Slave PIO

---

The choice: Auto (**default**), Mode0, Mode1, Mode2, Mode3, Mode4



Caution: Do not use the wrong setting or you will have drive errors

PIO means Programmed Input/output.

Rather than have the BIOS issue a series of commands to effect a transfer to or from the disk drive, PIO allows the BIOS to tell the controller what it wants and then let the controller and the CPU perform the complete task by themselves.

Your system supports five modes, 0 (default) to 4, which primarily differ in timing.

When Auto is selected, the BIOS will select the best available mode after checking your drive.

Auto	The BIOS will automatically set the system according to your hard disk drive's timing ( <b>default</b> ).
Mode 0-4	You can select a mode that matches your hard disk drive's timing.

## IDE Primary/Secondary, Master/ Slave UDMA

---

The choice: Disabled, Auto (**default**)

## On-Chip Secondary PCI IDE

---

These fields allow you to enable or disable the primary and secondary IDE controller.

Select disabled if you want to add a different hard drive controller.

The choice: Enabled (**default**), Disabled.

## On-Chip Serial ATA

Choose the status of serial ATA, the default setting is "Auto" which let system to arrange all parallel and serial

Disabled	Will disable SATA controller. <b>(Figure 11)</b>
Combined Mode	Will combine PATA and SATA, and max of 2 IDE drives in each channel. <b>(Figure 12)</b>
Enhanced Mode	Will enable both SATA and PATA, and max of 6 IDE drives is supported. <b>(Figure 13)</b>
SATA Only	Means SATA is operating in legacy mode. <b>(Figure 14)</b>
Auto	This is the default setting.

ATA resource automatically.

The choice: Disabled, Auto **(default)**, Combined Mode, Enhanced Mode, SATA Only.

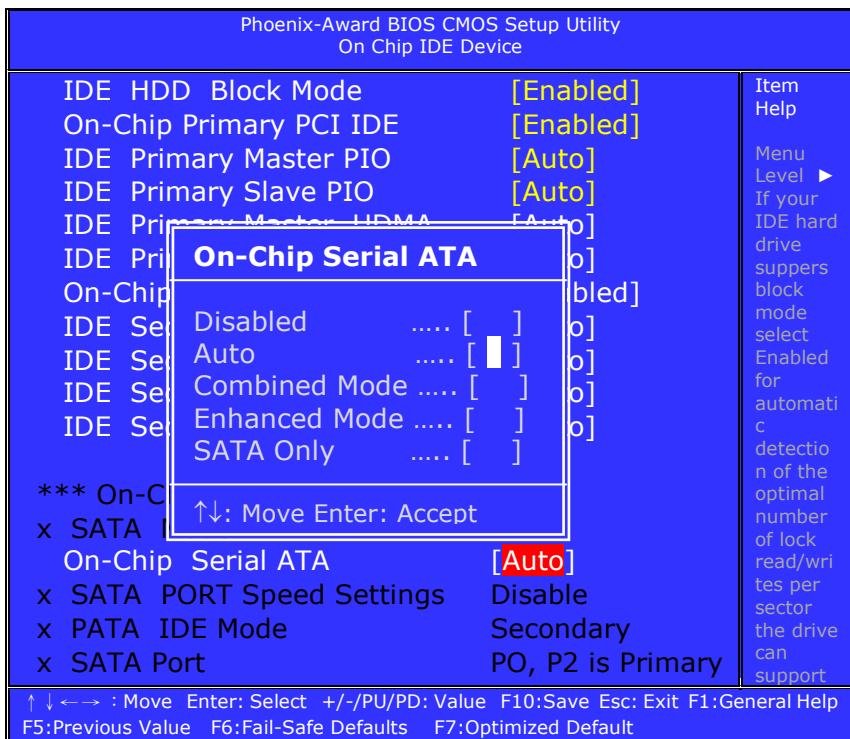

**(Figure 10)**

When you press [Disabled] or [Auto] on this item will show: [Auto] is the default choice.

Phoenix-Award BIOS CMOS Setup Utility		Item Help
On Chip IDE Device		
IDE HDD Block Mode	[Enabled]	Menu Level ► If your IDE hard drive supports block mode select Enabled for automatic detection of the optimal number of lock read/writes per sector the drive can support
On-Chip Primary PCI IDE	[Enabled]	
IDE Primary Master PIO	[Auto]	
IDE Primary Slave PIO	[Auto]	
IDE Primary Master UDMA	[Auto]	
IDE Primary Slave UDMA	[Auto]	
On-Chip Secondary PCI IDE	[Enabled]	
IDE Secondary Master PIO	[Auto]	
IDE Secondary Slave PIO	[Auto]	
IDE Secondary Master UDMA	[Auto]	
IDE Secondary Slave UDMA	[Auto]	
*** On-Chip Serial ATA Setting***		
x SATA Mode	IDE	
On-Chip Serial ATA	[Auto]	
x SATA PORT Speed Settings	Disable	
x PATA IDE Mode	Secondary	
x SATA Port	PO, P2 is Primary	
↑↓←→ : Move    Enter: Select    +/-/PU/PD: Value    F10:Save    Esc: Exit    F1:General Help F5:Previous Value    F6:Fail-Safe Defaults    F7:Optimized Default		

(Figure11)

**When you press [Combined Mode] on this item will show:**

Phoenix-Award BIOS CMOS Setup Utility On Chip IDE Device			
IDE HDD Block Mode	[Enabled]	<b>Item Help</b>  Menu Level ► If your IDE hard drive supports block mode select Enabled for automatic detection of the optimal number of lock read/writes per sector the drive can support	
On-Chip Primary PCI IDE	[Enabled]		
IDE Primary Master PIO	[Auto]		
IDE Primary Slave PIO	[Auto]		
IDE Primary Master UDMA	[Auto]		
IDE Primary Slave UDMA	[Auto]		
On-Chip Secondary PCI IDE	[Enabled]		
IDE Secondary Master PIO	[Auto]		
IDE Secondary Slave PIO	[Auto]		
IDE Secondary Master UDMA	[Auto]		
IDE Secondary Slave UDMA	[Auto]		
*** On-Chip Serial ATA Setting***			
SATA Mode	[IDE]		
On-Chip Serial ATA	[ <b>CombinedMod</b> ]		
x SATA PORT Speed Settings	Disable		
PATA IDE Mode	[Secondary]		
x SATA Port	PO, P2 is Primary		
↑ ↓ ← → : Move    Enter: Select    +/-/PU/PD: Value    F10:Save    Esc: Exit    F1:General Help F5:Previous Value    F6:Fail-Safe Defaults    F7:Optimized Default			

**(Figure12)**

### SATA Mode

Controls the SATA controller's operating mode.  
The choice: IDE (**default**), RAID, AHCI.

### PATA IDE Mode

This field is used to select the function mode of the IDE connector.

The only choice:

Secondary: IDE serves as Secondary Master and Secondary Slave channel. SATA 1 and SATA 2 serve as Primary Master and Primary Slave channel.

**When you press [Enhanced Mode] on this item will show:**

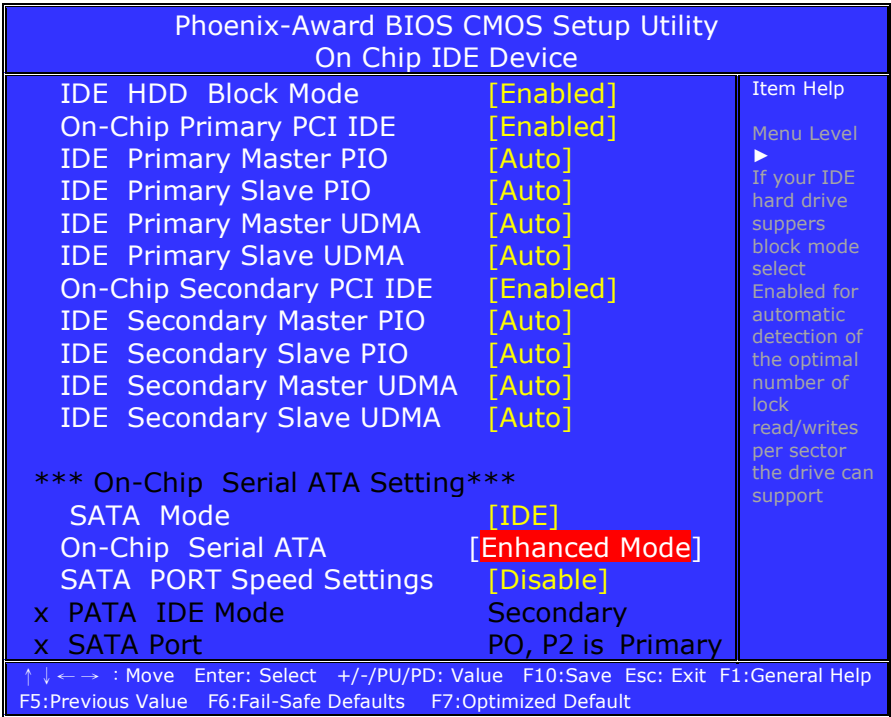

**(Figure13)**

**SATA Mode**

Controls the SATA controller's operating mode.  
 The choice: IDE (**default**), RAID, AHCI.

**SATA Port Speed Settings**

Select SATA speed.  
 The choice: Disabled (**default**), Force GEN I, Force GEN II.

**When you press [SATA Only] on this item will show:**

Phoenix-Award BIOS CMOS Setup Utility On Chip IDE Device			Item Help
IDE HDD Block Mode	[Enabled]		Menu Level ▶ If your IDE hard drive supports block mode select Enabled for automatic detection of the optimal number of lock read/write s per sector the drive can support
On-Chip Primary PCI IDE	[Enabled]		
IDE Primary Master PIO	[Auto]		
IDE Primary Slave PIO	[Auto]		
IDE Primary Master UDMA	[Auto]		
IDE Primary Slave UDMA	[Auto]		
On-Chip Secondary PCI IDE	[Enabled]		
IDE Secondary Master PIO	[Auto]		
IDE Secondary Slave PIO	[Auto]		
IDE Secondary Master UDMA	[Auto]		
IDE Secondary Slave UDMA	[Auto]		
*** On-Chip Serial ATA Setting***			
SATA Mode	[IDE]		
On-Chip Serial ATA	[SATA Only]		
x SATA PORT Speed Settings	Disable		
x PATA IDE Mode	Secondary		
x SATA Port	PO, P2 is Primary		
↑ ↓ ← → : Move Enter: Select +/-/PU/PD: Value F10:Save Esc: Exit F1:General Help F5:Previous Value F6:Fail-Safe Defaults F7:Optimized Default			

**(Figure14)**

### SATA Mode

Controls the SATA controller's operating mode.  
The choice: IDE (**default**), RAID, AHCI.

---

## ➤ On board Device

---

Phoenix-Award BIOS CMOS Setup Utility Onboard Device		
USB Controller	[Enabled]	Item Help
USB 2.0 Controller	[Enabled]	Menu Level ▶
USB Keyboard Support	[Disabled]	
Azalia/AC97 Audio Select	[Auto]	
↑ ↓ ← → : Move Enter: Select +/-/PU/PD: Value F10:Save Esc: Exit F1:General Help F5:Previous Value F6:Fail-Safe Defaults F7:Optimized Default		

### USB Controller

Select enabled if your system contains a Universal Serial Bus (USB) controller and you have USB peripherals.  
The choice: Enabled (**default**), Disabled.

### USB 2.0 Controller

This entry is for disable/enable USB2.0 controller only.  
The BIOS itself may/may not have high speed USB support.  
If the BIOS has high speed USB support built in, the support will be automatically turn on when high speed device were attached.  
The choice: Enabled (**default**), Disabled

### USB Keyboard Support

Select enabled if user plan to use an USB keyboard.  
The choice: Enabled, Disabled (**default**).

### Azalia/AC97 Audio Select

The choice: Auto (**default**), Azalia, AC97 Audio and Modem, AC97 Audio only, AC97 Modem only, ALL Disabled.

---

## ➤ Super IO Device

---

Phoenix-Award BIOS CMOS Setup Utility		
Super IO Device		
Onboard Serial Port 1	[3F8/IRQ4]	Item Help
Onboard Serial Port 2	[2F8/IRQ3]	Menu Level ►
UART Mode Select	[Normal]	
x RxD , TxD Active	Hi, Lo	
x IR Transmission Delay	Enabled	
x UR2 Duplex Mode	Half	
Onboard Parallel Port	[378/IRQ7]	
Parallel Port Mode	[SPP]	
x EPP Mode Select	EPP1.7	
x ECP Mode Use DMA	3	
PWRON After PWR-Fail	[Off]	

↑ ↓ ← → : Move Enter: Select +/-/PU/PD: Value F10:Save Esc: Exit  
F1:General Help F5:Previous Value F6:Fail-Safe Defaults F7:Optimized Default

### Onboard Serial Port 1

---

Select an address and corresponding interrupt for the first serial ports.

The choice: Disable, 3F8/IRQ4 (**default**), 2F8/IRQ3, 3E8/IRQ4, 2E8/IRQ3, Auto.

### Onboard Serial Port 2

---

Select an address and corresponding interrupt for the second serial ports.

The choice: Disable, 3F8/IRQ4, 2F8/IRQ3 (**default**), 3E8/IRQ4, 2E8/IRQ3, Auto.

---

## UART Mode Select

---

This item allows you to select which mode for the Onboard Serial Port 2.

The choice: IrDA, ASKIR, Normal (**default**)

**If UART Mode Select is IrDA and ASKIR will show:**

Phoenix-Award BIOS CMOS Setup Utility Super IO Device		
Onboard Serial Port 1	[3F8/IRQ4]	Item Help
Onboard Serial Port 2	[2F8/IRQ3]	
UART Mode Select	[IrDA]	Menu Level
RxD , TxD Active	[Hi, Lo]	▶
IR Transmission Delay	[Enabled]	
UR2 Duplex Mode	[Half]	
Onboard Parallel Port	[378/IRQ7]	
Parallel Port Mode	[SPP]	
x EPP Mode Select	EPP1.7	
x ECP Mode Use DMA	3	
PWRON After PWR-Fail	[Off]	
↑ ↓ ← → : Move Enter: Select +/-/PU/PD: Value F10:Save Esc: Exit F1:General Help F5:Previous Value F6:Fail-Safe Defaults F7:Optimized Default		

## RxD, TxD Active

---

The choice:

UART Mode Select	
Hi, Hi	.....[ ]
Hi, Lo	.....[ ]
Lo, Hi	.....[ ]
Lo, Lo	.....[ ]
↑↓: Move Enter: Accept ESC:	

## IR Transmission Delay

---

The choice: Disabled, Enabled (**default**).

## UR2 Duplex Mode

---

The choice: Full, Half (**default**).

---

## Onboard Parallel Port

---

This item allows you to determine onboard parallel port controller I/O address setting.

The choice: 378/IRQ7 (**default**), 278/IRQ5, 3BC/IRQ7, Disabled.

## Parallel Port Mode

---

The choice: SPP (**default**), EPP, ECP, ECP+EPP, Normal.

SPP	Sets the parallel port to function as a Standard Parallel Port. This is the default (and slowest) option.
EPP	Sets the parallel port to Enhanced Parallel Port mode. Sometimes also called "Bi-directional"
ECP	Sets the parallel port up as an Enhanced Capabilities Port. This setting requires the use of a DMA channel

**If Parallel Port Mode Select is [SPP] and [Normal] will show:**

Phoenix-Award BIOS CMOS Setup Utility Super IO Device		
Onboard Serial Port 1	[3F8/IRQ4]	Item Help
Onboard Serial Port 2	[2F8/IRQ3]	Menu Level ▶
UART Mode Select	[IrDA]	
RxD , TxD Active	[Hi, Lo]	
IR Transmission Delay	[Enabled]	
UR2 Duplex Mode	[Half]	
Onboard Parallel Port	[378/IRQ7]	
Parallel Port Mode	[SPP]	
x EPP Mode Select	EPP1.7	
x ECP Mode Use DMA	3	
PWRON After PWR-Fail	[Off]	
↑ ↓ ← → : Move Enter: Select +/-/PU/PD: Value F10:Save Esc: Exit F1:General Help F5:Previous Value F6:Fail-Safe Defaults F7:Optimized Default		

---

**If Parallel Port Mode Select is [EPP] will show:**

Phoenix-Award BIOS CMOS Setup Utility Super IO Device		
Onboard Serial Port 1	[3F8/IRQ4]	Item Help
Onboard Serial Port 2	[2F8/IRQ3]	Menu Level ►
UART Mode Select	[IrDA]	
RxD , TxD Active	[Hi, Lo]	
IR Transmission Delay	[Enabled]	
UR2 Duplex Mode	[Half]	
Onboard Parallel Port	[378/IRQ7]	
Parallel Port Mode	[EPP]	
EPP Mode Select	[1.7]	
x ECP Mode Use DMA	3	
PWRON After PWR-Fail	[Off]	
↑ ↓ ← → : Move Enter: Select +/-/PU/PD: Value F10:Save Esc: Exit F1:General Help F5:Previous Value F6:Fail-Safe Defaults F7:Optimized Default		

### **EPP Mode Select**

Select EPP port type 1.7 or 1.9.

The choice: 1.7 (**default**), 1.9.

---

**If Parallel Port Mode Select is [ECP] will show:**

Phoenix-Award BIOS CMOS Setup Utility		
Super IO Device		
Onboard Serial Port 1	[3F8/IRQ4]	Item Help
Onboard Serial Port 2	[2F8/IRQ3]	Menu Level ►
UART Mode Select	[IrDA]	
RxD , TxD Active	[Hi, Lo]	
IR Transmission Delay	[Enabled]	
UR2 Duplex Mode	[Half]	
Onboard Parallel Port	[378/IRQ7]	
Parallel Port Mode	[ECP]	
x EPP Mode Select	1.7	
ECP Mode Use DMA	[3]	
PWRON After PWR-Fail	[Off]	

↑ ↓ ← → : Move Enter: Select +/-/PU/PD: Value F10:Save Esc: Exit F1:General  
Help F5:Previous Value F6:Fail-Safe Defaults F7:Optimized Default

### **ECP Mode Use DMA**

If your system supports ECP parallel port mode and you have the port set to use ECP, you must use this setting to assign a DMA channel for use by the port.

The choice: DMA1, DMA3 **(default)**.

---

**If Parallel Port Mode Select is [ECP+EPP] will show:**

Phoenix-Award BIOS CMOS Setup Utility Super IO Device		
Onboard Serial Port 1	[3F8/IRQ4]	Item Help
Onboard Serial Port 2	[2F8/IRQ3]	Menu Level ▶
UART Mode Select	[IrDA]	
RxD , TxD Active	[Hi, Lo]	
IR Transmission Delay	[Enabled]	
UR2 Duplex Mode	[Half]	
Onboard Parallel Port	[378/IRQ7]	
Parallel Port Mode	[ECP+EPP]	
EPP Mode Select	[1.7]	
ECP Mode Use DMA	[3]	
PWRON After PWR-Fail	[Off]	

↑ ↓ ← → : Move Enter: Select +/-/PU/PD: Value F10:Save Esc: Exit F1:General Help  
F5:Previous Value F6:Fail-Safe Defaults F7:Optimized Default

---

### EPP Mode Select

Select EPP port type 1.7 or 1.9.  
The choice: 1.7 (**default**), 1.9.

---

### ECP Mode Use DMA

If your system supports ECP parallel port mode and you have the port set to use ECP, you must use this setting to assign a DMA channel for use by the port.  
The choice: DMA1, DMA3 (**default**).

---

### PWRON After PWR-Fail

When power fails, you can select power ON or Off or Former status.  
The choice: Off (**default**), On, Former-Sts.

---

## **Onboard Serial Port 3**

---

This is used to select an I/O address for the onboard serial port 3.

The choice: Disabled, 3F8, 2F8, 3E8 **(default)**, 2E8

## **Serial Port 3 Use IRQ**

---

This is used to select an IRQ for the onboard serial port 3.

The choice: IRQ3 **(default)**, IRQ4, IRQ5, IRQ7, IRQ10, IRQ11.

## **Onboard Serial Port 4**

---

This is used to select an I/O address for the onboard serial port 4.

The choice: Disabled, 3F8, 2F8, 3E8, 2E8 **(default)**.

## **Serial Port 4 Use IRQ**

---

This is used to select an IRQ for the onboard serial port 4.

The choice: IRQ3, IRQ4 **(default)**, IRQ5, IRQ7, IRQ10, IRQ11.

## **Onboard Serial Port 5**

---

This is used to select an I/O address for the onboard serial port 5

The choice: Disabled, 4F8 **(default)**, 4E8.

## **Serial Port 5 Use IRQ**

---

This is used to select an IRQ for the onboard serial port 5.

The choice: IRQ3, IRQ4, IRQ5 **(default)**, IRQ7, IRQ10, IRQ11.

## **Onboard Serial Port 6**

---

This is used to select an I/O address for the onboard serial port 6.

The choice: Disabled, 4F8, 4E8 **(default)**.

---

## **Serial Port 6 Use IRQ**

---

This is used to select an IRQ for the onboard serial port 6. The choice: IRQ3, IRQ4, IRQ5, IRQ7 **(default)**, IRQ10, IRQ11

## **Watch Dog Timer Select**

---

The choice: Disabled **(default)**, Enable

## 3.6 Power Management Setup

The Power Management Setup allows you to configure you system to most effectively save energy while operating in a manner consistent with your own style of computer use.

Phoenix-Award BIOS CMOS Setup Utility Power Management Setup		Item Help
▶ PCI Express PM Function	[Press Enter]	Menu Level ▶
Power-Supply Type	[AT]	
ACPI Function	[Enabled]	
Power Management	[User Define]	
Video Off Method	[DPMS]	
Video Off In Suspend	[Yes]	
Suspend Type	[Stop Grant]	
MODEM Use IRQ	[3]	
Suspend Mode	[Disabled]	
HDD Power Down	[Disabled]	
Soft-Off by PWR-BTTN	[Instant-Off]	
CPU THRM-Throttling	[50.0%]	
Wake-Up by PCI card	[Enabled]	
Power On by Ring	[Enabled]	
Resume by Alarm	[Disabled]	
x Data(of Month)Alarm	0	
x Time(hh: mm: ss)Alarm	0 : 0 : 0	
<b>**Reload Global Timer Events**</b>		
Primary IDE 0	[Disabled]	
Primary IDE 1	[Disabled]	
Secondary IDE 0	[Disabled]	
Secondary IDE 1	[Disabled]	
FDD , COM , LPT Port	[Disabled]	
PCI PIRQ[A-D]#	[Disabled]	
↑ ↓ ← → : Move    Enter: Select    +/-/PU/PD: Value    F10:Save    Esc: Exit    F1:General Help F5:Previous Value    F6:Fail-Safe Defaults    F7:Optimized Default		

---

## ►PCI Express PM Function

---

Phoenix-Award BIOS CMOS Setup Utility PCI Express PM Function	
PCI Express PME [Enabled]	Item Help Menu Level ►
↑ ↓ ← → : Move Enter: Select +/-/PU/PD: Value F10:Save Esc: Exit F1:General Help F5:Previous Value F6:Fail-Safe Defaults F7:Optimized Default	

### PCI Express PME

---

The choice: Enabled (**default**), Disabled.

### Power-Supply Type

---

The choice: AT (**default**), ATX

### ACPI Function

---

This item allows you to enable/disable the Advanced Configuration and Power Management (ACPI).

The choice: Enabled (**default**), Disabled.

### Power Management

---

The choice: User Define (**default**), Min Saving, Max Saving.

Max Saving	Maximum power savings. Only Available for SL CPUs. Inactivity period is 1 minute in each mode.
User Define	Set each mode individually. Select time-out periods in the section for each mode, below.
Min Saving	Minimum power savings. Inactivity period is 1 hour in each mode (except the hard drive).

---

## Video off Method

---

This determines the manner in which the monitor is blanked.

This specifies the power saving state that the VGA video subsystem enters after the specified period of display inactivity has expired.

The choice: Blank Screen, V/H SYNC+ Blank, DPMS **(default)**.

Blank Screen	The BIOS will only black the screen when the system gets into power management mode and writes blanks to the video buffer.
V/H SYNC + Blank	Writes blanks to the video buffer, and turns off the vertical and horizontal scanning.
DPMS	Allows the BIOS to control the video display card if it supports the DPMS feature <b>(default)</b> .

---

## Video Off In Suspend

---

This field is used to activate the video off feature when the system enters the Suspend mode.

The choice: No, Yes **(default)**.

---

## Suspend Type

---

The choice: Stop Grant **(default)**, PwrOn Suspend

---

## MODEM Use IRQ

---

This field is used to set an IRQ channel for the modem installed in your system.

The choice: NA, 3 **(default)**, 4, 5, 7, 9, 10, 11.

---

## Suspend Mode

---

This field specifies the length of time of system inactivity while in full power on state before the computer enters suspend mode and motivates the enable 'Wake up Events in Doze & Standby' / 'PM Events'.

The choice: 1Min, 2Min, 4Min, 8Min, 12Min, 20Min, 30Min, 40Min, 1Hour, Disable **(default)**.

---

---

## HDD Power Down

---

When enable and after the set time of system inactivity, the hard disk drive will be powered down while all other devices remain active.

The choice: 1Min, 2Min, 3Min, 4Min, 5Min, 6Min, 7Min, 8Min, 9Min, 10Min, 11Min, 12Min, 13Min, 14Min, 15Min, Disable **(default)**.

## Soft-Off by PWR-BTTN

---

This field defines the power off mode when using an ATX power supply.

The choice: Instant-Off, Delay 4 Sec.

Instant-Off	Press power button then Power off instantly <b>(default)</b>
Delay 4 Sec	Press power button 4 sec. to Power off. Enter suspend if button is pressed less than 4 sec.

## CPU THRM-Throttling

---

This field allows you to select the CPU THRM-Throttling rate.

The choice: 75.0%, 50.0% **(default)**, 25.0%.

## Wake-Up by PCI card

---

Enable/Disable PCI PME wake up function.

The choice: Enabled **(default)**, Disabled.

## Power On by Ring

---

Enable/Disable Power On By Ring function.

The choice: Enabled **(default)**, Disabled.

---

## Resume by Alarm

---

You can set "Resume by Alarm" item to enabled and key in Date/time to power on system.

The choice: Enabled, Disabled (**default**)

**If Resume by Alarm is [Enabled], can choice Date Alarm and Time Alarm:**

### Date (of Month) Alarm

---

Every day, 1~31

Date(of Moth)Alarm
Min= 0 Max= 31
Key in a DEC number: <input type="text"/>
↑↓: Move Enter: Accept ESC:Abort

### Time (hh: mm: ss) Alarm

---

(0~23): (0~59): (0~59)

Time (hh: mm: ss) Alarm
Min= 0 Max= 23
Key in a DEC number: <input type="text"/>
↑↓: Move Enter: Accept ESC:Abort

### Primary/ Secondary IDE 0/1

---

When Enabled, the system will resume from suspend mode if Primary IDE 0 (1) or Secondary IDE 0 (1) is active.

The choice: Enabled, Disabled (**default**)

---

## **FDD, COM, LPT Port**

---

When Enabled, the system will resume from suspend mode if FDD, COM port, or LPT port is active.  
The choice: Enabled, Disabled **(default)**.

## **PCI PIRQ [A-D] #**

---

When Enabled, the system will resume from suspend mode if interrupt occurs.  
The choice: Enabled, Disabled **(default)**.

## 3.7 PnP/PCI Configuration

This section describes configuring the PCI bus system. PCI, or Personal Computer Interconnect, is a system which allows I/O devices to operate at speeds nearing the speed the CPU itself uses when communicating with its own special components. This section covers some very technical items and it is strongly recommended that only experienced users should make any changes to the default settings.

Phoenix-Award BIOS CMOS Setup Utility PnP/PCI Configuration		
Init Display First	[PCI Slot]	Item Help
Reset Configuration Data	[Disabled]	Menu Level ▶
Resources Controlled By	[Auto(ESCD)]	
x IRQ Resources	Press Enter	
PCI/VGA Palette Snoop	[Disabled]	
INT Pin 1 Assignment	[Auto]	
INT Pin 2 Assignment	[Auto]	
INT Pin 3 Assignment	[Auto]	
INT Pin 4 Assignment	[Auto]	
INT Pin 5 Assignment	[Auto]	
INT Pin 6 Assignment	[Auto]	
INT Pin 7 Assignment	[Auto]	
INT Pin 8 Assignment	[Auto]	
**PCI Express relative items**		
Maximum Payload Size	[4096]	
↑ ↓ ← → : Move    Enter: Select    +/-/PU/PD: Value    F10: Save    Esc: Exit    F1: General Help F5: Previous Value    F6: Fail-Safe Defaults    F7: Optimized Default		

### Init Display First

This item allows you to choose which one to activate first, PCI Slot or onchip VGA.

The choice: PCI Slot (**default**), Onboard, PCIEx.

---

## Reset Configuration Data

---

Default is disabled. Select Enabled to reset Extended System Configuration Data (ESCD) when you exit Setup if you have installed a new add-on and the system reconfiguration has caused such a serious conflict that the OS cannot boot.

The choice: Enabled, Disabled (**default**).

## Resources Controlled By

---

BIOS can automatically configure all the boot and Plug and Play compatible devices. If you choose Auto, you cannot select IRQ DMA and memory base address fields, since BIOS automatically assigns them.

The choice: Auto (ESCD) (**default**), Manual.

**If Resources Controlled By is [Manual], can choice IRQ Resource:**

Phoenix-Award BIOS CMOS Setup Utility PnP/PCI Configuration		
Init Display First	[PCI Slot]	Item Help Menu Level ▶
Reset Configuration Data	[Disabled]	
Resources Controlled By	[Manual]	
▶ IRQ Resources	[Press Enter]	
PCI/VGA Palette Snoop	[Disabled]	
INT Pin 1 Assignment	[Auto]	
INT Pin 2 Assignment	[Auto]	
INT Pin 3 Assignment	[Auto]	
INT Pin 4 Assignment	[Auto]	
INT Pin 5 Assignment	[Auto]	
INT Pin 6 Assignment	[Auto]	
INT Pin 7 Assignment	[Auto]	
INT Pin 8 Assignment	[Auto]	
**PCI Express relative items**		
Maximum Payload Size	[4096]	
↑ ↓ ← → : Move Enter: Select +/-/PU/PD: Value F10:Save Esc: Exit F1:General Help F5:Previous Value F6:Fail-Safe Defaults F7:Optimized Default		

## ➤IRQ Resource

When resources are controlled manually, assign each system interrupt a type, depending on the type of device using the interrupt. This item allows you to determine the IRQ assigned to the ISA bus and is not available to any PCI slot.

Phoenix-Award BIOS CMOS Setup Utility IRQ Resource		
IRQ-3 assigned to	[PCI Device]	Item Help  Menu Level ► Legacy ISA for devices compliant with the original PC AT bus specification, PCI/ISA PnP for devices compliant with the Plug and Play standard whether designed for PCI or ISA bus architecture
IRQ-4 assigned to	[PCI Device]	
IRQ-5 assigned to	[PCI Device]	
IRQ-7 assigned to	[PCI Device]	
IRQ-9 assigned to	[PCI Device]	
IRQ-10 assigned to	[PCI Device]	
IRQ-11 assigned to	[PCI Device]	
IRQ-12 assigned to	[PCI Device]	
IRQ-14 assigned to	[PCI Device]	
IRQ-15 assigned to	[PCI Device]	
↑↓←→ : Move Enter: Select +/-/PU/PD: Value F10:Save Esc: Exit F1:General Help F5:Previous Value F6:Fail-Safe Defaults F7:Optimized Default		

### IRQ-3,4,5,7,9,10,11,12,14,15 assigned to

IRQ-3 assigned to	
PCI Device	..... [ █ ]
Reserved	..... [ ] ]
↑↓: Move Enter: Accept	

The choice: PCI Device, Reserved.

---

## **PCI/VGA Palette Snoop**

---

This BIOS feature determines if your graphics card should allow VGA palette snooping by a fixed function display card.

The choice: Enabled, Disabled (**default**).

## **INT Pin 1/2/3/4/5/6/7/8 Assignment**

---

The choice: Auto (**default**), 3, 4, 5, 7, 9, 10, 11, 12, 14, 15.

## **Maximum Payload Size**

---

The choice: 128 (**default**), 256, 512, 1024, 2048, 4096.

---

## 3.8 PC Health Status

This section helps you to get more information about your system including CPU temperature, FAN speed and voltages. It is recommended that you contact with your motherboard supplier to get proper value about your setting of the CPU temperature.

Phoenix-Award BIOS CMOS Setup Utility PC Health Status		
CPU Warning Temperature	[Disabled]	Item Help
Current System Temp.	40°C / 107°F	Menu Level ▶
Current CPU Temperature:	40°C / 100°F	
CPU FAN Speed	0 RPM	
CHASSIS Fan Speed	7670 RPM	
Vcore	1.20V	
+1.5V	1.52V	
+3.3V	3.47V	
+5V	5.16V	
+12V	12.22V	
-12V	-12.44V	
VBAT(V)	3.32V	
5VSB(V)	5.04V	
Shutdown Temperature	[Disabled]	
↑ ↓ ← → : Move Enter: Select +/-/PU/PD: Value F10:Save Esc: Exit F1:General Help F5:Previous Value F6:Fail-Safe Defaults F7:Optimized Default		

---

### CPU Warning Temperature

Select the CPU over-heated warning temperature.  
The choice: Disabled (**default**), 50°C/122°F, 53°C/127°F, 56°C/133°F, 60°C/140°F, 63°C/145°F, 66°C/151°F, 70°C/158°F.

---

### Current System Temp

Show System Temperature.

---

### Current CPU Temperature

Shows Board Temperature

---

## **CPU FAN Speed**

---

Shows CPU Fan speed.

## **CHASSIS Fan Speed**

---

Shows CHASSIS Fan speed

## **Shutdown Temperature**

---

Select the CPU over-heated shutdown temperature.

The choice: Disabled (**default**), 60°C/140°F, 65°C/149°F, 70°C/158°F, 75°C/167°F

---

## 3.9 Frequency/Voltage Control

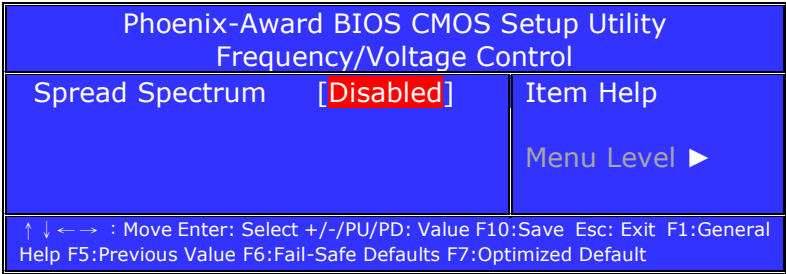

### Spread Spectrum

Leave this field in its default setting. Do not alter this setting unless advised by an engineer or technician. The choice: Disabled (**default**), +/-0.1%, +/-0.2%, +/-0.3%, +/-0.4%, +/-0.5%, +/-0.6%, +/-0.7%, +/-0.8%, +/-0.9%.

## 3.10 Load Fail-Safe Defaults

When you press <Enter> on this item you get a confirmation dialog box with a message similar to:

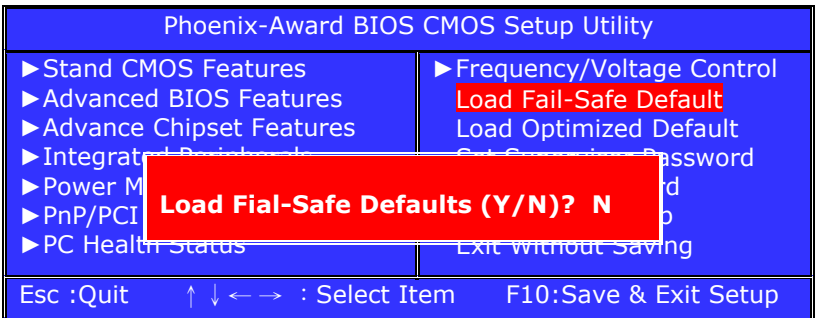

Pressing 'Y' loads the BIOS default values for the most stable, minimal-performance system operations.

---

### 3.11 Load Optimized Defaults

When you press <Enter> on this item you get a confirmation dialog box with a message similar to:

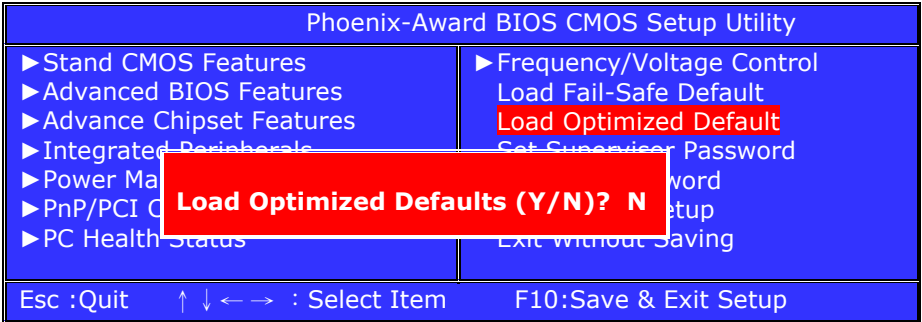

Pressing 'Y' loads the default values that are factory settings for optimal performance system operations.

### 3.12 Set Supervisor/User Password

You can set either supervisor or user password, or both of them. The differences between are:

**Supervisor password:** can enter and change the options of the setup menus.

**User password:** just can only enter but do not have the right to change the options of the setup menus. When you select this function, the following message will appear at the center of the screen to assist you in creating a password.

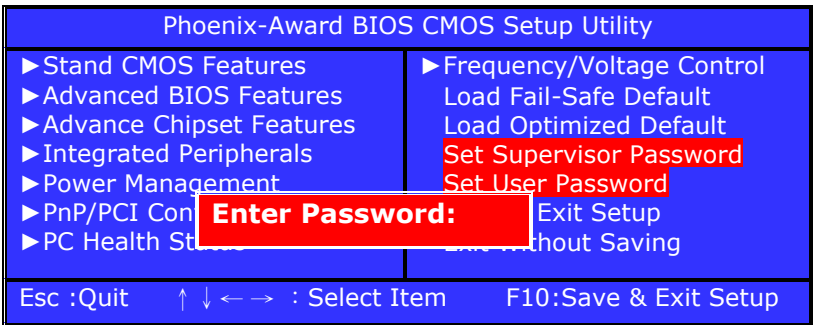

### ENTER PASSWORD:

Type the password, up to eight characters in length, and press <Enter>. The password typed now will clear any previously entered password from CMOS memory. You will be asked to confirm the password. Type the password again and press <Enter>. You may also press <Esc> to abort the selection and not enter a password.

To disable a password, just press <Enter> when you are prompted to enter the password. A message will confirm the password will be disabled. Once the password is disabled, the system will boot and you can enter Setup freely.

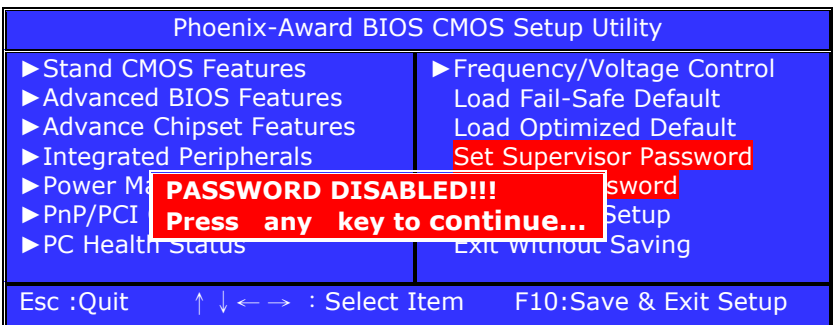

---

## PASSWORD DISABLED:

When a password has been enabled, you will be prompted to enter it every time you try to enter Setup. This prevents an unauthorized person from changing any part of your system configuration.

Additionally, when a password is enabled, you can also require the BIOS to request a password every time your system is rebooted. This would prevent unauthorized use of your computer.

You determine when the password is required within the BIOS Features Setup Menu and its Security option. If the Security option is set to "System", the password will be required both at boot and at entry to Setup. If set to "Setup", prompting only occurs when trying to enter Setup.

## 3.13 Save & Exit Setup

Pressing <Enter> on this item asks for confirmation:

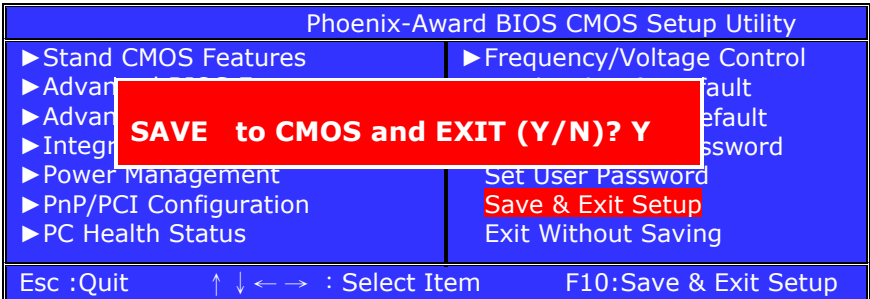

Pressing "Y" stores the selections made in the menus in CMOS – a special section of memory that stays on after you turn your system off. The next time you boot your computer, the BIOS configures your system according to the Setup selections stored in CMOS. After saving the values the system is restarted again.

---

## 3.14 Exit Without Saving

Pressing <Enter> on this item asks for confirmation:

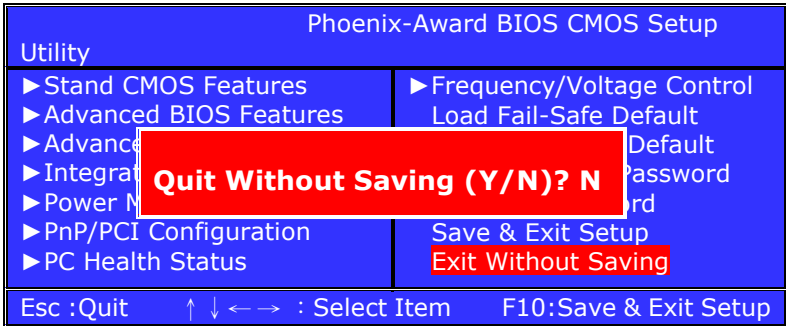

This allows you to exit Setup without storing in CMOS any change. The previous selections remain in effect. This exits the Setup utility and restarts your computer.

# Appendix

---

AC Power Adapter .....	98
I/O Port Address Map .....	99
Interrupt Request Lines (IRQ) .....	100
POST Beep .....	101
Resistive Touchscreen Option .....	102-108
TR-LCD1500-ITX Mechanical Drawings .....	109-120

# AC Power Adapter

Below is the AC power adapter for the TR-LCD1500-ITX industrial computer. A 6' HP style power cord is included.

Other voltages that are available for this system are: 12V, 24V, 48V, 125V and 250V DC.



---

## ***A. I/O Port Address Map***

Each peripheral device in the system is assigned a set of I/O port addresses which also becomes the identity of the device. There is a total of 1K port address space available. The following table lists the I/O port addresses used on the Industrial PC.

<b>Address</b>	<b>Device Description</b>
000h - 01Fh	DMA Controller #1
020h - 03Fh	Interrupt Controller #1
040h - 05Fh	Timer
060h - 06Fh	Keyboard Controller
070h - 07Fh	Real Time Clock, NMI
080h - 09Fh	DMA Page Register
0A0h - 0BFh	Interrupt Controller #2
0C0h - 0DFh	DMA Controller #2
0F0h	Clear Math Coprocessor Busy Signal
0F1h	Reset Math Coprocessor
1F0h - 1F7h	IDE Interface
278 - 27F	Parallel Port #2(LPT2)
2F8h - 2FFh	Serial Port #2(COM2)
2B0 - 2DF	Graphics adapter Controller
378h - 3FFh	Parallel Port #1(LPT1)
360 - 36F	Network Ports
3B0 - 3BF	Monochrome & Printer adapter
3C0 - 3CF	EGA adapter
3D0 - 3DF	CGA adapter
3F0h - 3F7h	Floppy Disk Controller
3F8h - 3FFh	Serial Port #1(COM1)

---

## ***B. Interrupt Request Lines (IRQ)***

There are a total of 15 IRQ lines available on the Industrial PC. Peripheral devices use interrupt request lines to notify CPU for the service required. The following table shows the IRQ used by the devices on the Industrial PC.

<b>Level</b>	<b>Function</b>
IRQ0	System Timer Output
IRQ1	Keyboard
IRQ2	Interrupt Cascade
IRQ3	Serial Port #2
IRQ4	Serial Port #1
IRQ5	Reserved
IRQ6	Floppy Disk Controller
IRQ7	Parallel Port #1
IRQ8	Real Time Clock
IRQ9	Software Redirected to Int 0Ah
IRQ10	Reserved
IRQ11	Reserved
IRQ12	PS/2 Mouse
IRQ13	80287
IRQ14	Primary IDE
IRQ15	Secondary IDE

---

## ***C. POST Beep***

Currently there are two kinds of beep codes in BIOS. This code indicates that a **video error** has occurred and the BIOS cannot initialize the video screen to display any additional information.

This beep code consists of a single long beep followed by two short beeps.

The other code indicates that your **DRAM error** has occurred. This beep code consists of a single long beep repeatedly.

# Resistive Touchscreen Option

## USB Controller Driver Installation

All Windows drivers are included on the Transduction **TR-LCD1500-ITX** 8-wire Touchscreen Drivers CD along with Troubleshooting.

**NOTE:** For Win XP and 2000 you **MUST** logon with administrator's password.

**TouchKit** software on the driver CD has the required drivers and the utility for toggling between left and right mouse buttons and configuration support. These will all be installed when Setup.exe is run from the CD.

### For Windows 2000/XP

**NOTE:** [Download USB Touch Screen Driver For Windows 2K/XP](#)

When the New Hardware Found message comes up, choose **Cancel**. Run the **Setup.exe** program from the driver CD.

Please note that the touch screen controller in the TR-LCD1500-ITX is **USB** and follow the prompts accordingly.

Windows will copy the files to your hard drive and setup will be complete. (Windows XP will give a warning message about the TouchKit Controller certification, press **Continue** anyway.)

Please reboot your computer.

Windows will now find the device automatically and it will be listed in the Device Manager as: *TouchKit USB Controller*.

### TouchKit Software

There are five property pages:

1. **GENERAL:** Language selection, add/remove devices, 4-point Calibration, Draw Test and Advanced

#### 4 pts Cal

Choose to calibrate your screen by touching the blinking symbol on the panel until you get a beep or it stops blinking



#### Draw Test

Test the drawing position in relation to the display screen to verify panel linearity, calibration capability and drawing line quality.

### Advanced

A 25 Point calibration utility for the touch sensor.

Press **Clear** to clear previous calibration records.

Press **25 pts Cal** to do 25 point calibration by touching the blinking symbol on the panel until you get a beep or it stops blinking. After calibration, the new record will overwrite the old one.



## 2. SETTING: Sound, Mouse Mode and Double Click Adjustment

### Sound

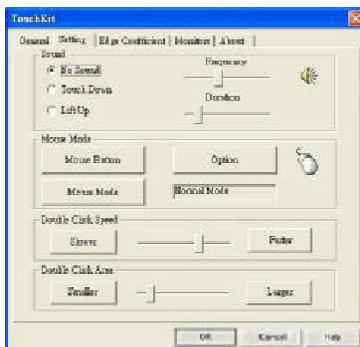

#### No Sound

Choose to make no sound when panel is touched.

#### Touch Down

Beep will sound when panel is touched.

#### Lift Up

The system will not make any sound until finger leaves the touch panel.

#### Frequency

Sound frequency, drag the cursor from left to right = low to high.

#### Duration

Sound duration, drag the cursor from left to right = short to long.

## Mouse Mode

The **Mouse Mode** provides users different operating options.

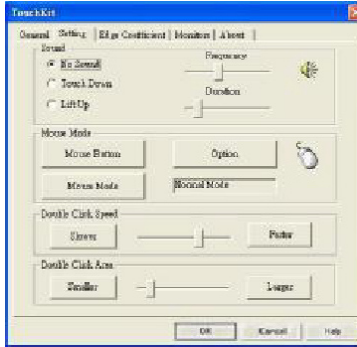

## Mouse Button

Click it to **show/hide Touch Tray** on the right bottom corner of the desktop. Users can choose show or hide **Touch Tray** from the mouse icon in the taskbar.

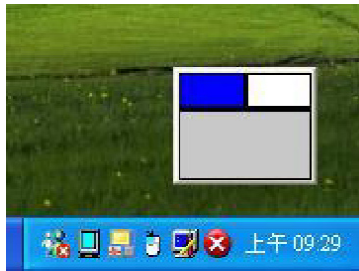

Change **right/left** button by clicking the upper small rectangular box of **Touch Tray**. Blue area indicates which button has been selected.

## Shutdown utility



Click on shutdown utility in the task bar



Shutdown utility dialog

There are five modes in shutdown utility:

**[Standby]** to enter standby mode that saves power consumption.

**[Shutdown]** to turn off PC.

**[Reboot]** to restart PC.

**[Cancel]** to escape from the Shutdown utility dialog.

**[Exit]** to disable the Shutdown utility.

**Please note that Windows NT does not support this function.**

## Mouse Mode

There are three mouse modes:

### [Normal Mode]

Provides all the mouse functions, including the dragging function.

### [Click on Touch]

Click action is executed as soon as panel is touched.

### [Click on Release]

Click action will not be executed until finger leaves the panel.

## Option

*Touchkit* provides an option for advanced Mouse Emulation setting. When the **Option** button is pressed, a setting property sheet will pop up. **Support Constant Touch** and **Support Auto Right Button** check boxes are shown in the property sheet to **enable/disable constant touch** and **Auto right button** support.



## Constant Touch

Enable **Constant Touch** to force driver to stop reporting touch points when movement is slight. You will see a stabilized cursor instead of a chattering cursor when users touch the same point. Eliminates unwanted noise.

## Auto Right Button

Enable **Auto Right Button** to force driver to report a **right click mouse event** to OS when users lift up from a **constant touch**. You no longer need to touch the **right button** in the touchtray to activate a right click. This makes it easier to right click.

## Cursor Visibility

Cursor visibility function allows the cursor to be hidden.

Go to **Start / Control Panel / Mouse / Pointers / Scheme**, and choose **TouchKit Hide Cursor**. Press **[Apply]** to make the setting change, and press **[OK]** to escape the property page.

## Double Click Adjustment

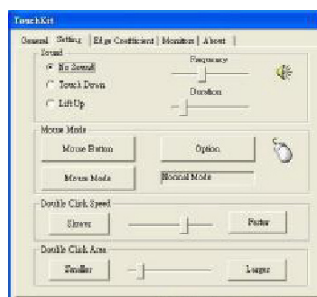

### Double Click Speed

Double Click Speed is the double click response time for the Windows system. Users can adjust the speed for easy double click by touch panel.

### Double Click Area

Each individual touch has its own touch tolerance. If the Double Click Area is set to <Smaller>, the panel will be very sensitive about micro-movements when you want to fix on a point. If set to <Larger>, larger touch point movement is tolerated when you want to point at a fixed position.

### 3. EDGE COEFFICIENT: Edge compensation for Top, Bottom, Left, Right, X Axis and Y Axis

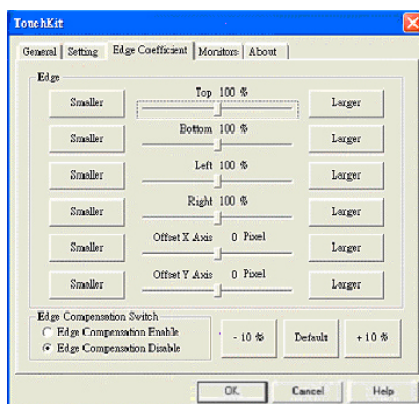

If it is difficult to touch items at the edges of the touch panel, you can adjust the edges of the screen image.

#### Top

If you set the Edge to <Smaller>, TouchKit will reduce the horizontal position of the top edge. If you set the Edge to <Larger>, TouchKit will extend the horizontal position of the top edge.

#### Bottom

If you set the Edge to <Smaller>, TouchKit will reduce the horizontal position of the bottom edge. If you set the Edge to <Larger>, TouchKit will extend the horizontal position of the bottom edge.

#### Left

If you set the Edge to <Smaller>, TouchKit will reduce the vertical position of the left edge. If you set the Edge to <Larger>, TouchKit will extend the vertical position of the left edge.

#### Right

If you set the Edge to <Smaller>, TouchKit will reduce the vertical position of the right edge. If you set the Edge to <Larger>, TouchKit will extend the vertical position of the right edge.

In some cases, the cursor will be behind the finger when you touch the panel. If you cannot see the cursor, you can set the X Axis or Y Axis to move the cursor.

### Offset X Axis

If you set the Offset X Axis to **<Smaller>**, cursor will be moved one pixel to the left of the X Axis. If you set the Offset X Axis to **<Larger>**, cursor will be moved one pixel to the right of the X Axis.

### Offset Y Axis

If you set the Offset Y Axis to **<Smaller>**, cursor will be moved one pixel above the Y Axis. If you set the Offset Y Axis to **<Larger>**, cursor will be moved one pixel below the Y Axis.

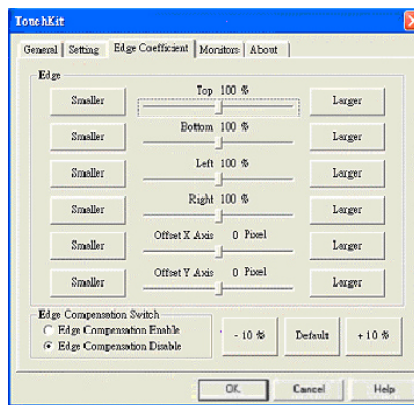

### Edge Compensation Switch

Use the **+10%** and **-10%** button to adjust. If you press the **+10%** button, the top, bottom, left and right edges will extend 10%, and the cursor will be moved 10 pixels from the X and Y Axis to the right and top. If you press the **-10%** button, the top, bottom, left and right edges will contract 10%, and cursor will be moved 10 pixels from the X and Y Axis to the left and bottom.

Choose the **Default** button to restore the default settings.

## 4. MONITORS: Multiple Monitors, Split Monitor

### Multiple Monitors

To configure the mapping relationship between the monitors and the touch panels, select the monitor page as below.

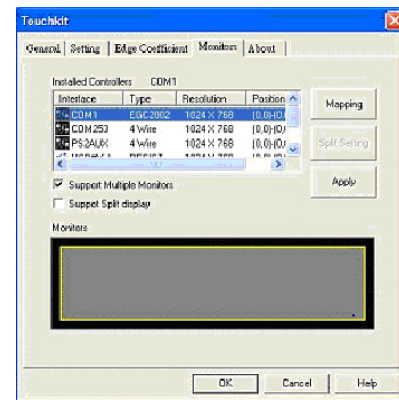

Set the check box (Use Multiple Monitors) to enable multiple monitors mapping. Unchecking this box will disable multiple-monitor configuration, and all of the touch panel controllers will be mapped to the primary monitor. The gray shadow area is the monitor mapped to the selected controller/panel. The button **[Mapping]** is used to find the mapping relationships between the monitors and touch panel controllers. Press **[Mapping]** and the software will guide you to touch the corresponding monitor to obtain the mapping relationship.



After completing monitor mapping, Press **[Apply]** to apply the mapping relationship.

### Split Monitors

To use the Split Monitor function, you need to select which controller you want to launch this function, then check the Multiple Monitors box and Split Monitor at the same time as shown below. Press the **[Split Monitor]** button to set up the active area.

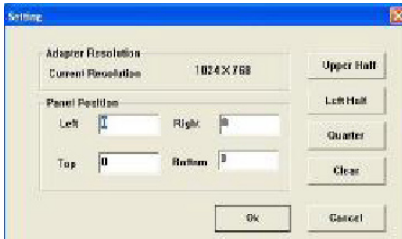

It shows the current resolution of the display and you can set the active area by inputting the value or use the default button **[Upper Half]**, **[Left Half]** or **[Quarter]**. The default value of panel resolution should be full screen as Left: **0**, Right: **0**, Top: **0** and Bottom: **0**.

5. **ABOUT**: General information about TouchKit.

### Uninstalling TouchKit

To uninstall, use the TouchKit/Uninstall from the Programs menu on the Start button.

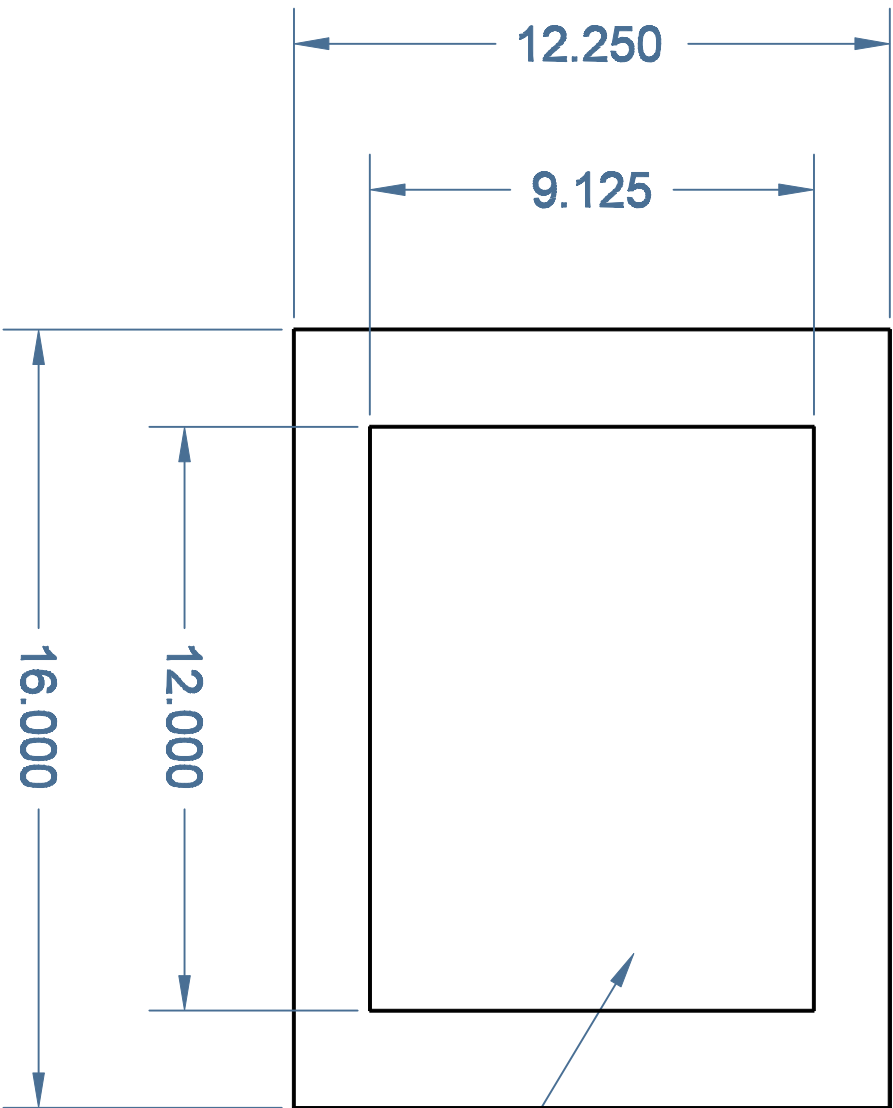

15" LCD MONITOR

**FRONT VIEW**

DATE	08-07-2009	DRAWN BY	B.G.	MODEL	TR-ITX-1500
PRODUCT	PANEL MOUNT VERSION		REVISION	SCALE	
FINISH	CRINKLE BLACK	TRANSDUCTION	CHECKED BY	NTS	
TITLE	LAYOUT		DRAWING No	B-457	

DETACHABLE POWER SUPPLY

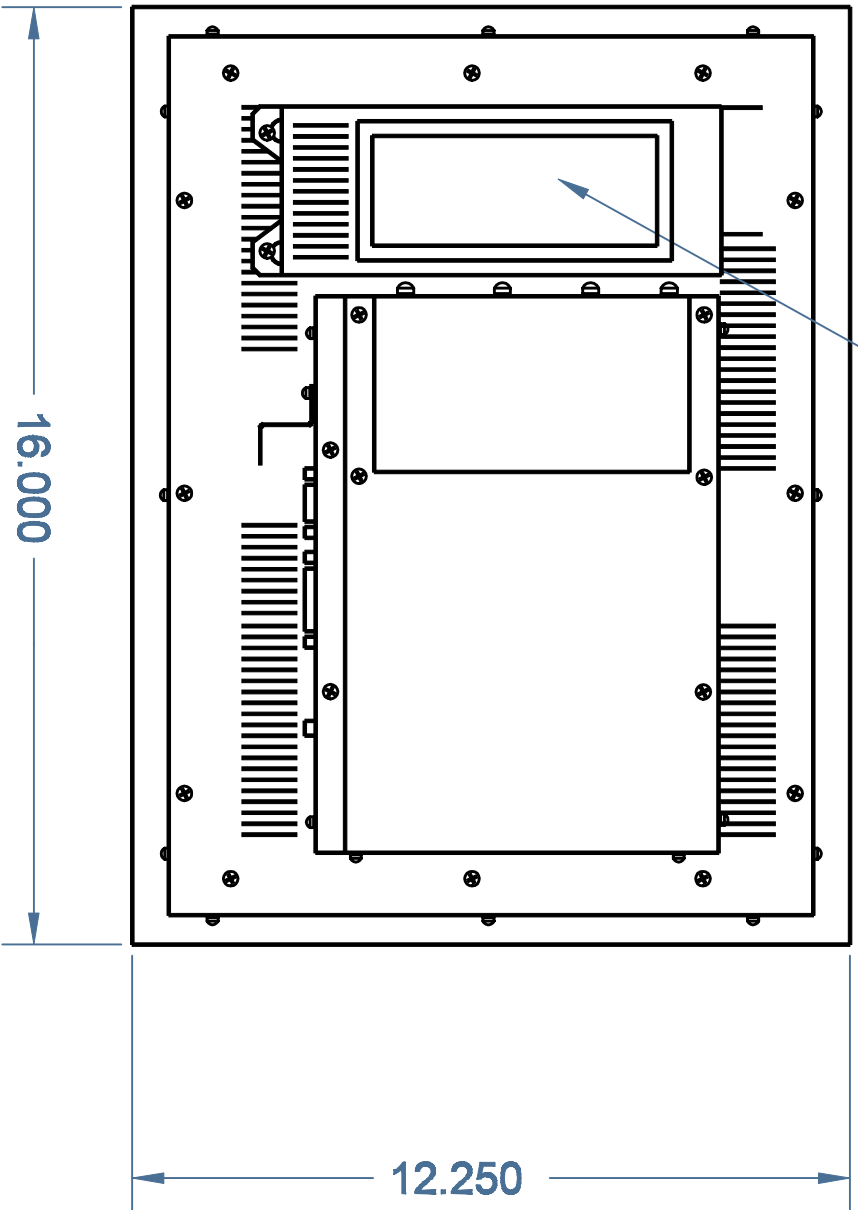

REAR VIEW

DATE	08-07-2009	DRAWN BY	B.G.	MODEL	TR-ITX-1500	REVISION		SCALE	
PRODUCT	PANEL MOUNT VERSION								
FINISH	Transaction					CHECKED BY	NTS		
TITLE	LAYOUT		DRAWING No	B-458					

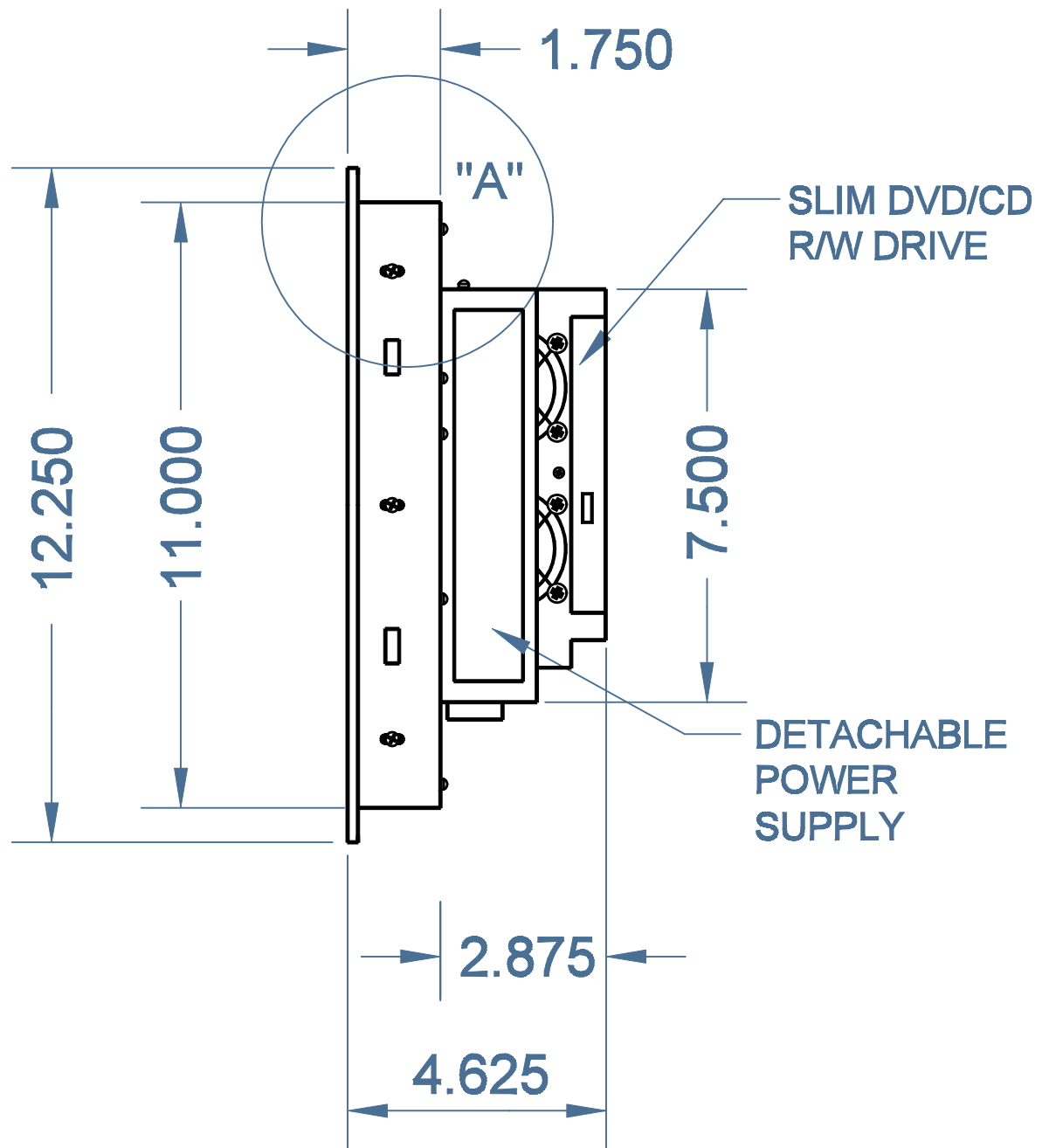

RIGHT SIDE VIEW

NOTE: FOR DETAIL "A" LOOK  
DRAWING B-462

DATE 08-07-2009	DRAWN BY B. G.	MODEL TR-ITX-1500		
PRODUCT PANEL MOUNT VERSION		REVISION	SCALE	
FINISH CRINKLE BLACK POWDER PAINT	Transduction	CHECKED BY	NTS	
TITLE LAYOUT		DRAWING No B-459		

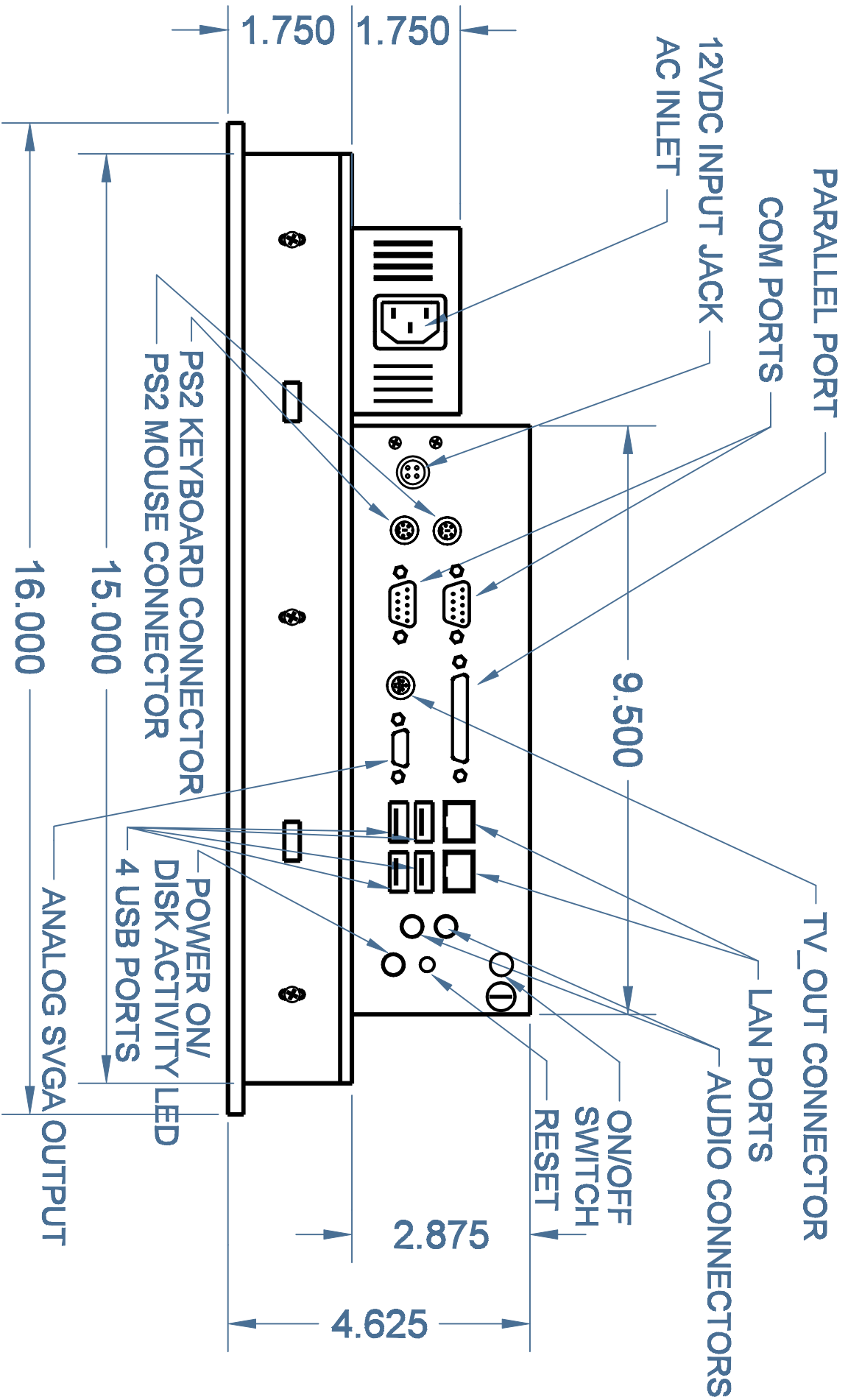

## BOTTOM VIEW

DATE	08-07-2009	DRAWN BY	B.G.	MODEL	TR-ITX-1500
PRODUCT	PANEL MOUNT VERSION		REVISION		
FINISH	CRINKLE BLACK	TRANSDUCTION	CHECKED BY	NTS	
TITLE	LAYOUT		DRAWING No	B-460	
SCALE	NTS				

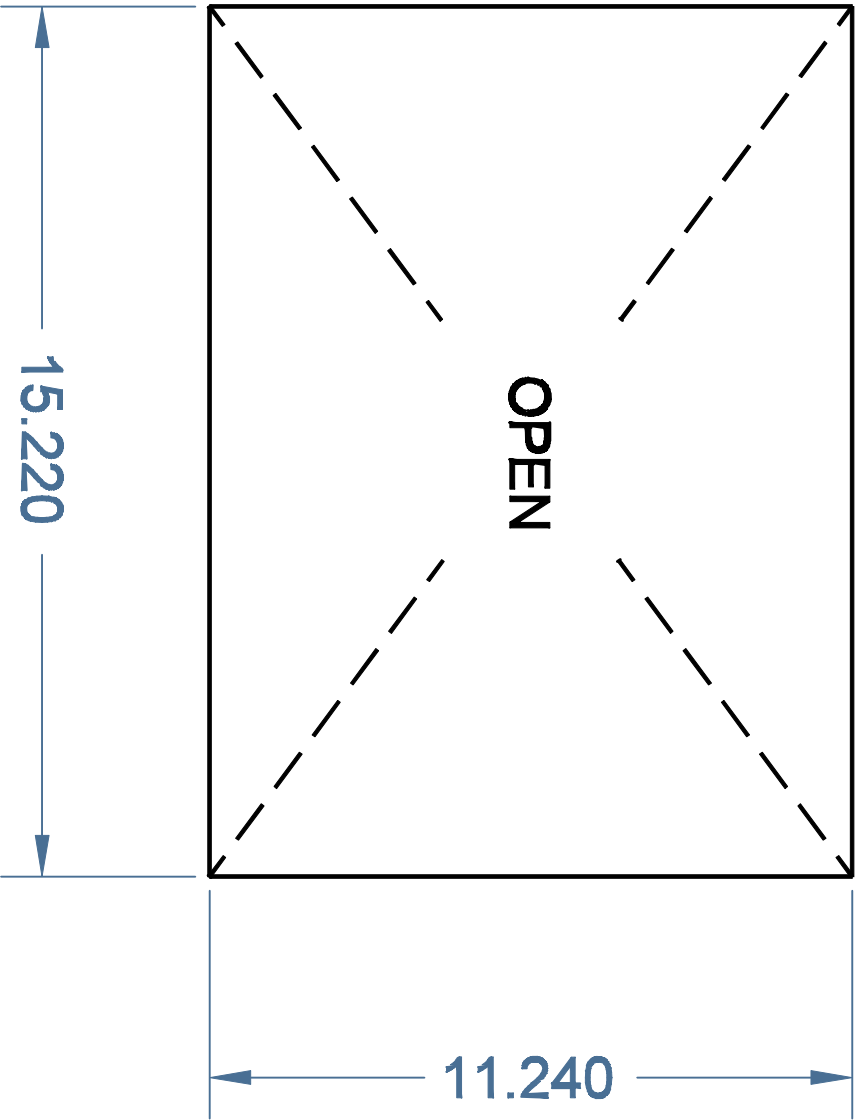

DATE	08-07-2009	DRAWN BY	B.G.	MODEL	TR-ITX-1500
PRODUCT	PANEL MOUNT VERSION			REVISION	
FINISH	Transduction			CHECKED BY	NTS
TITLE	CUTOUT			DRAWING NO	B-461

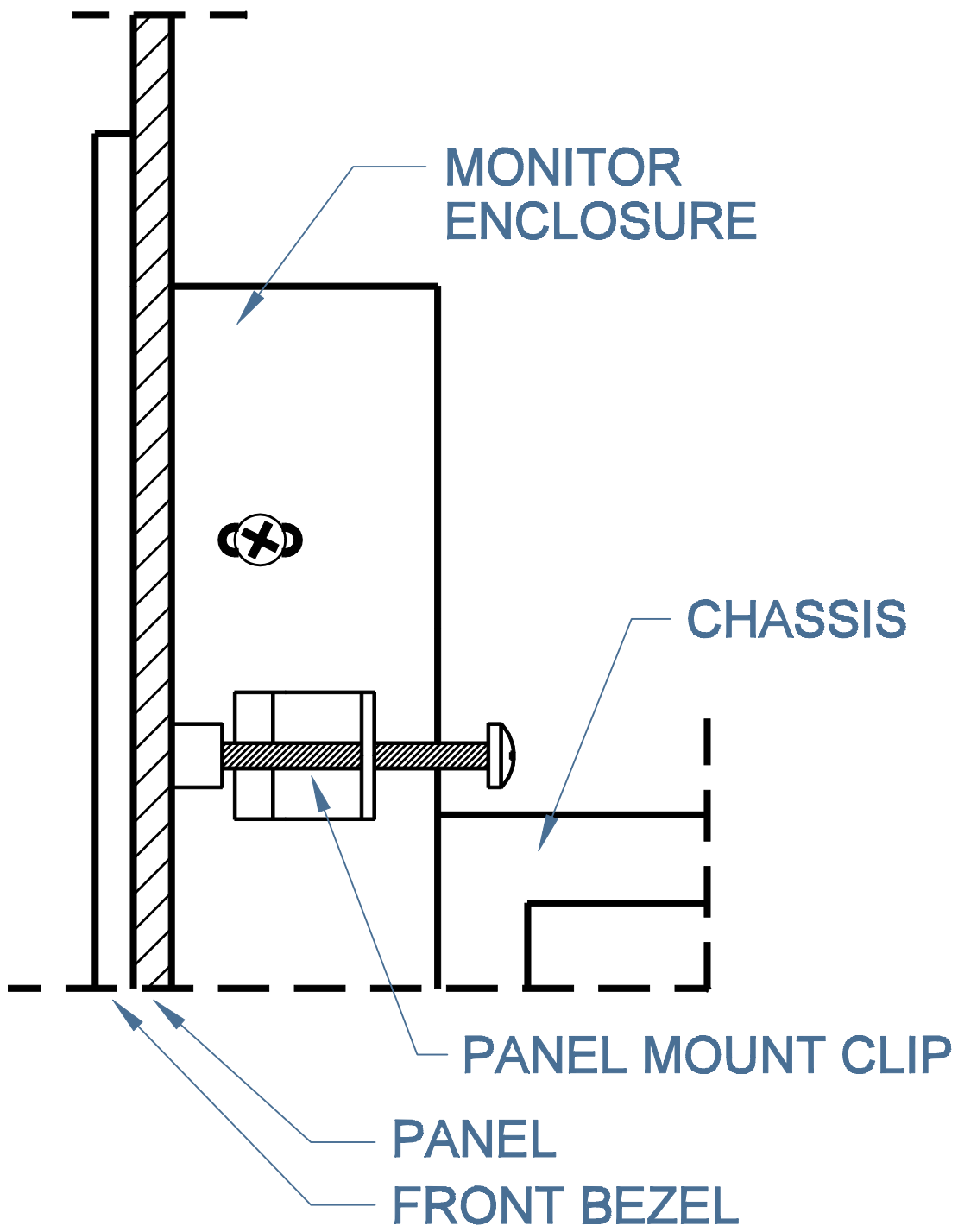

**NOTE: CLIP ATTACHED FROM BEHIND AFTER CHASSIS PLACEMENT IN THE PANEL OPENING**

DATE <b>08-07-2009</b>	DRAWN BY <b>B. G.</b>	MODEL <b>TR-ITX-1500</b>
PRODUCT <b>PANEL MOUNT VERSION</b>		REVISION <b>SCALE</b>
FINISH	<b>Transduction</b>	CHECKED BY <b>NTS</b>
TITLE <b>DETAIL "A"</b>		DRAWING No <b>B-462</b>

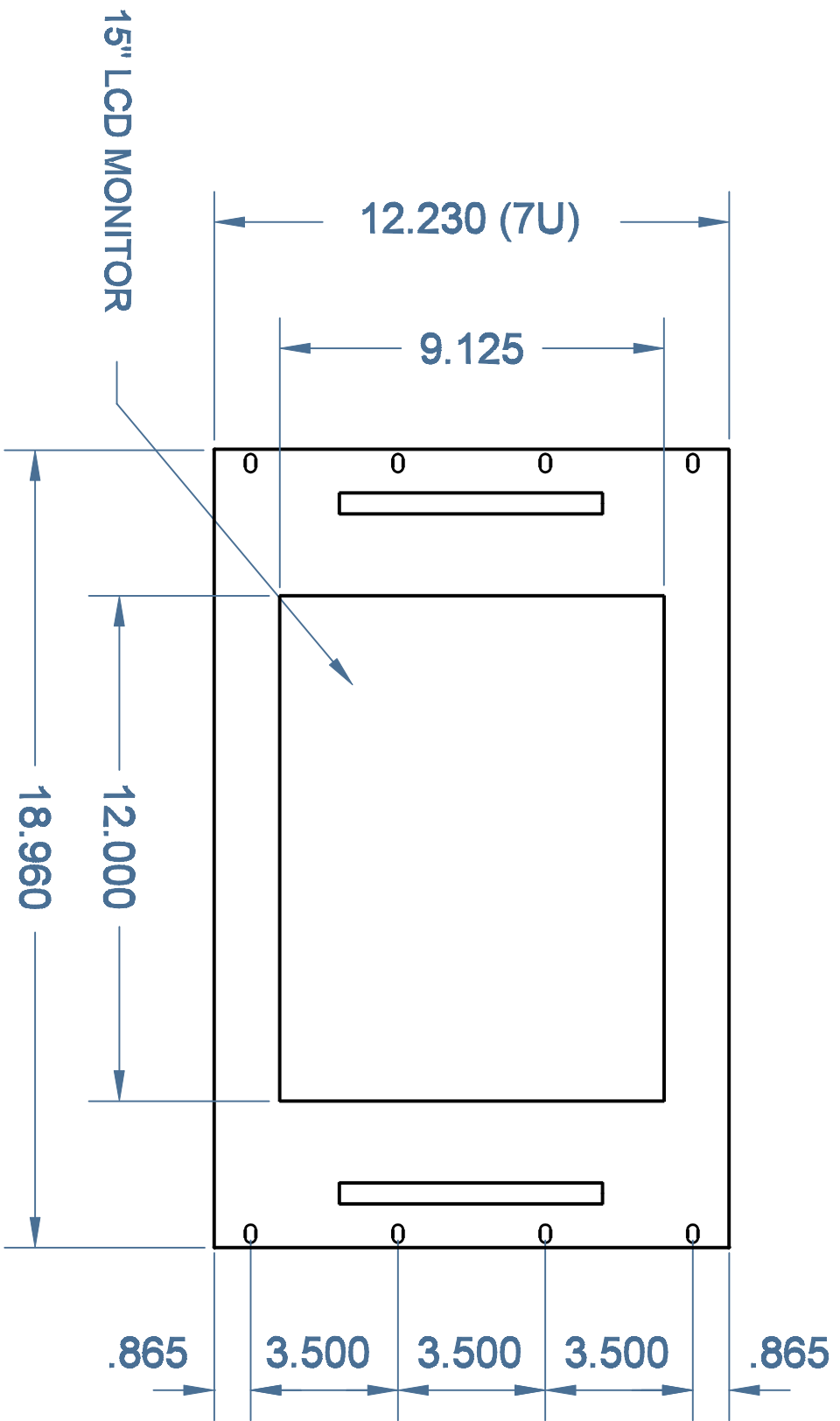

**FRONT VIEW**

DATE	08-07-2009	DRAWN BY	B.G.	MODEL	TR-ITX-1500
PRODUCT	RACK MOUNT VERSION		REVISION		
FINISH	CRINKLE BLACK POWDER PAINT	Transduction	CHECKED BY	NTS	
TITLE	LAYOUT			DRAWING No	B-463
SCALE					

DETACHABLE POWER SUPPLY

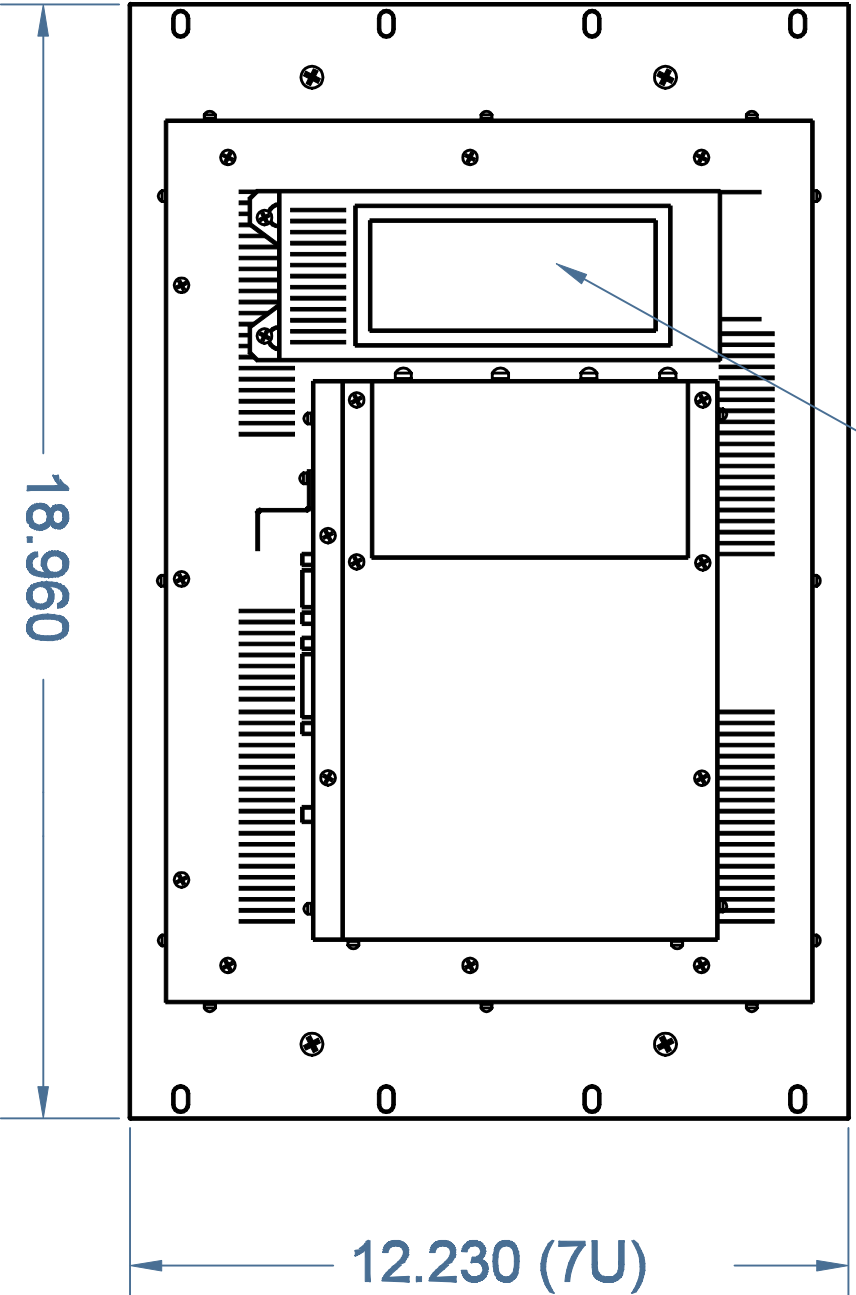

REAR VIEW

DATE	08-07-2009	DRAWN BY	B.G.	MODEL	TR-ITX-1500
PRODUCT	RACK MOUNT VERSION			REVISION	
FINISH	Transduction			CHECKED BY	NTS
TITLE	LAYOUT			DRAWING No	B-464

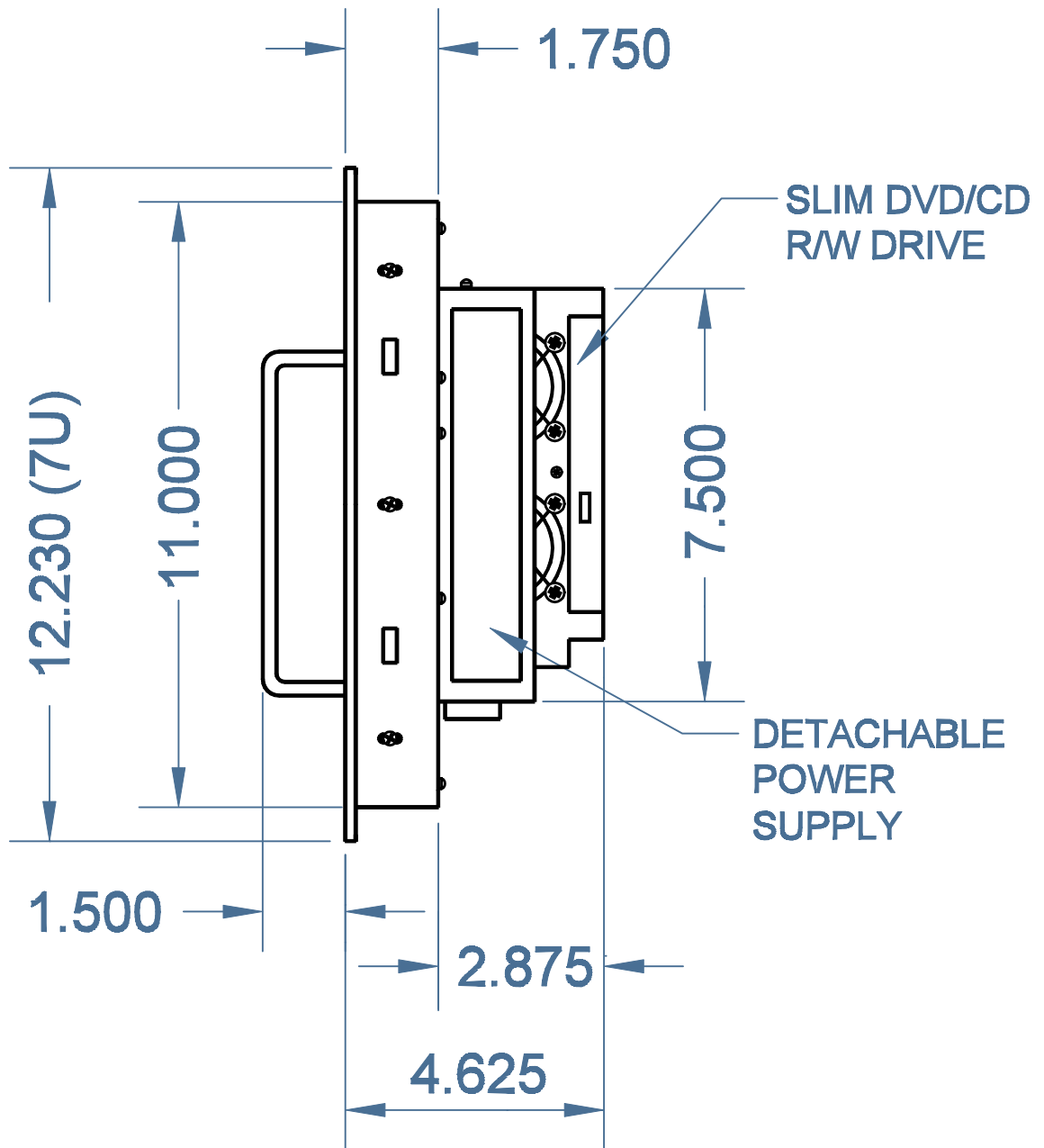

**RIGHT SIDE VIEW**

DATE <b>08-07-2009</b>	DRAWN BY <b>B. G.</b>	MODEL <b>TR-ITX-1500</b>		
PRODUCT <b>RACK MOUNT VERSION</b>		REVISION	SCALE	
FINISH <b>CRINKLE BLACK POWDER PAINT</b>	Transduction		CHECKED BY	<b>NTS</b>
TITLE <b>LAYOUT</b>		DRAWING No <b>B-465</b>		

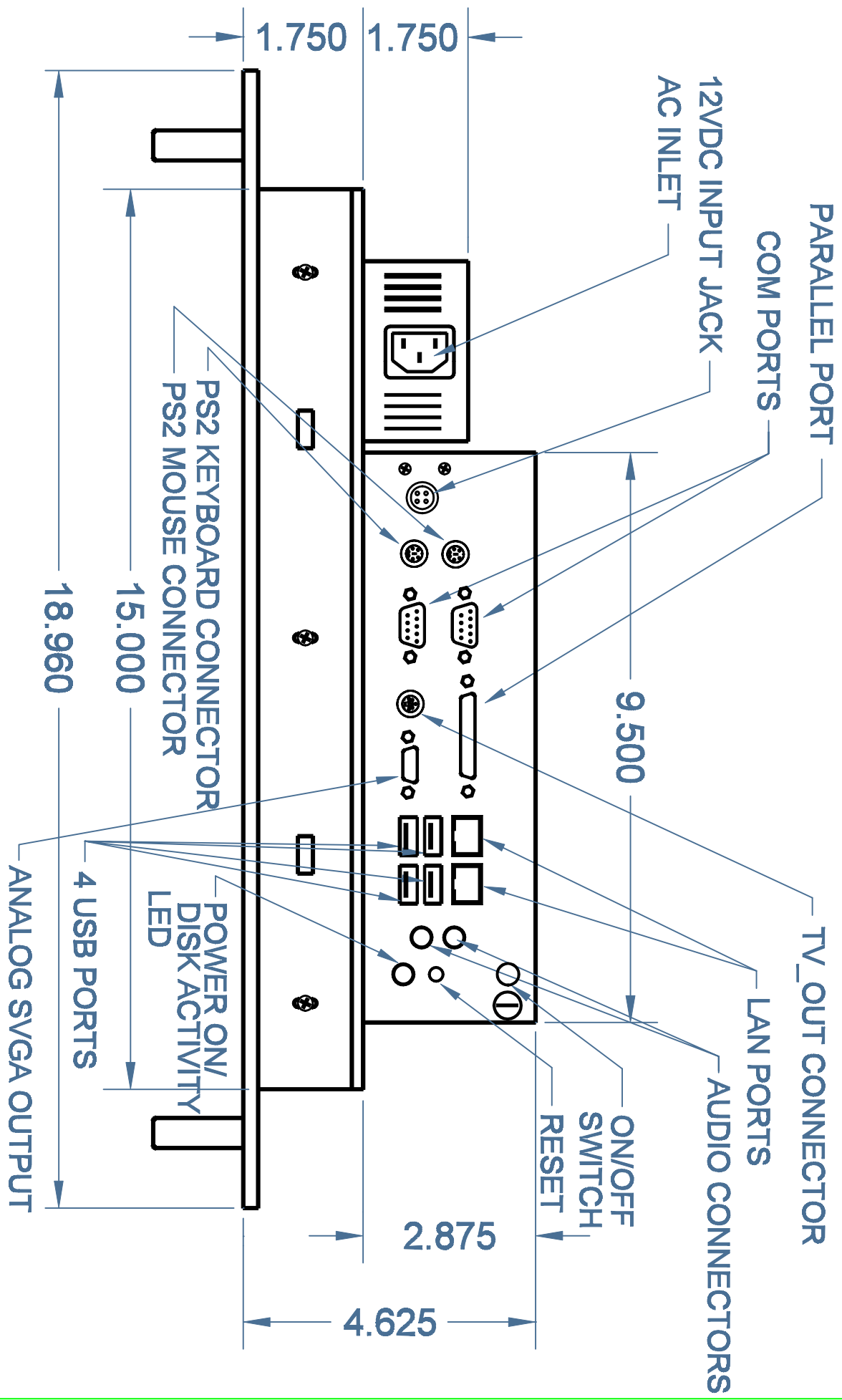

**BOTTOM VIEW**

DATE	08-07-2009	DRAWN BY	B.G.	MODEL	TR-ITX-1500
PRODUCT	RACK MOUNT VERSION			REVISION	
FINISH	CRINKLE BLACK	POWDER PAINT	Transduction	CHECKED BY	NTS
TITLE	LAYOUT			DRAWING No	B-466
SCALE	NTS				

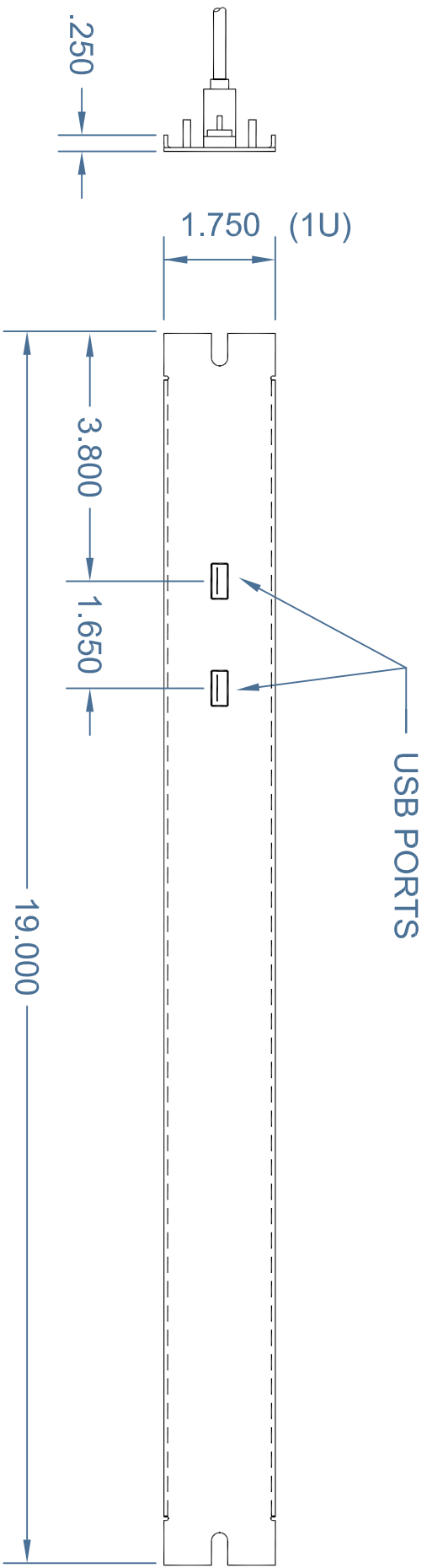

SIDE VIEW

FRONT VIEW

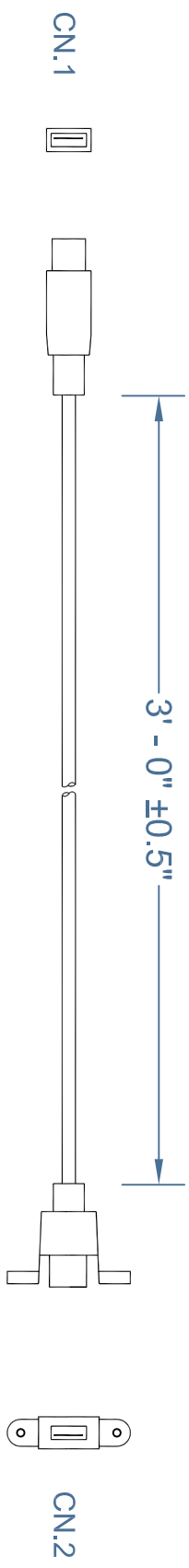

TWO USB CABLES  
MOUNTED ON THE PLATE

DATE	02-01-2010	DRAWN BY	B.G.	MODEL	1U USB FILLER
FINISH	SANDTEX BLACK PAINT	REVISION		CHECKED BY	NTS
TITLE	TR-RM-USB PLATE				SCALE
	LAYOUT		DRAWING NO		B-436A

STUD #6-32 x .500 4 PLACES FOR PANEL MOUNTING

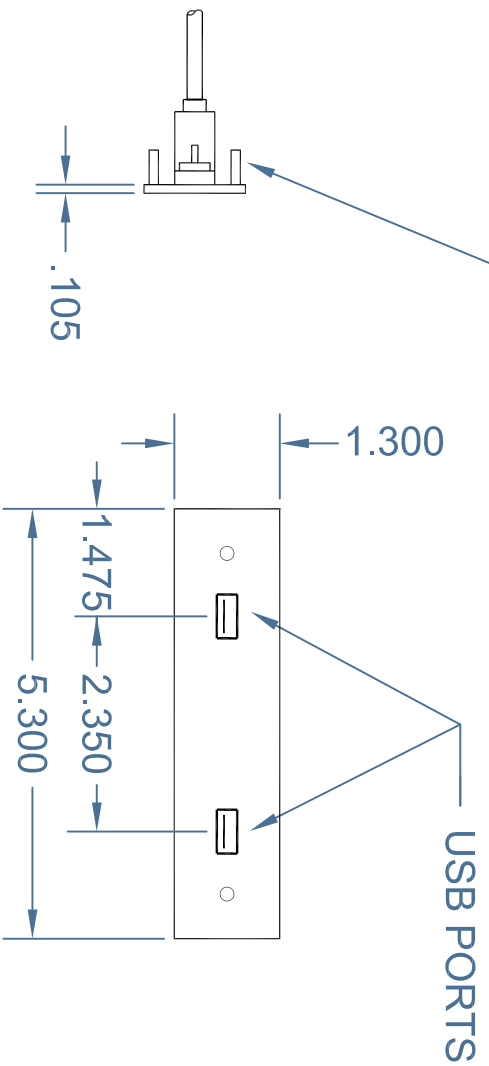

USB PORTS

Ø.166 4 PLACES

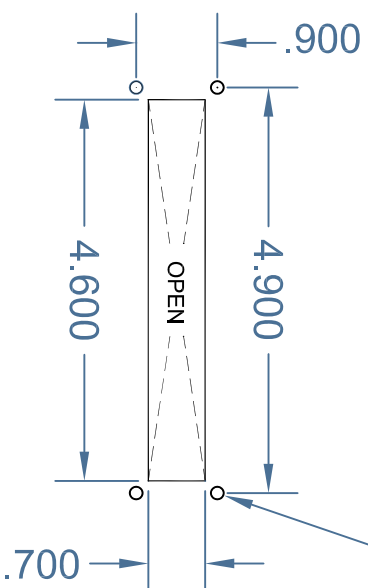

SIDE VIEW

FRONT VIEW

PANEL CUTOUT

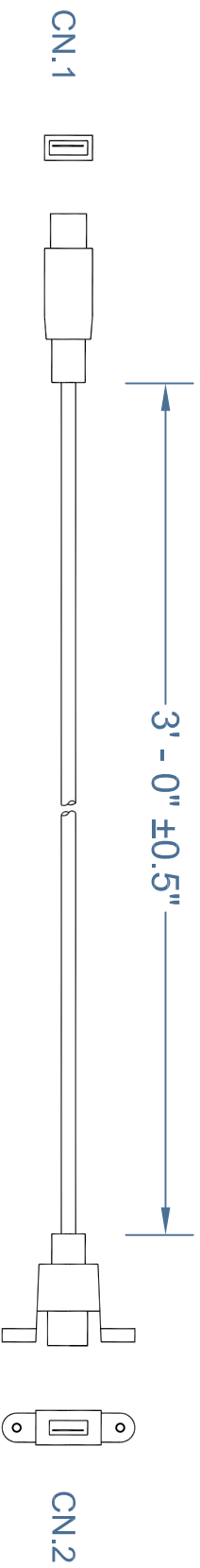

TWO USB CABLES

MOUNTED ON THE PLATE

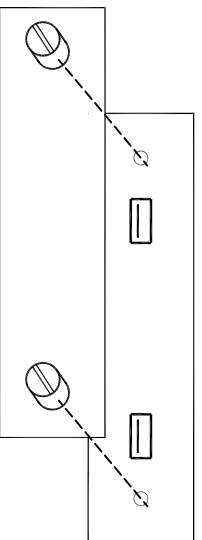

COVER PLATE

DATE	02-01-2010	DRAWN BY	B.G.	MODEL	FILLER PLATE
FINISH	SANDTEX BLACK PAINT	CHECKED BY	Transduction	REVISION	SCALE
TITLE	LAYOUT			DRAWING NO.	B-476A
					NTS