

# TRANSDUCTION

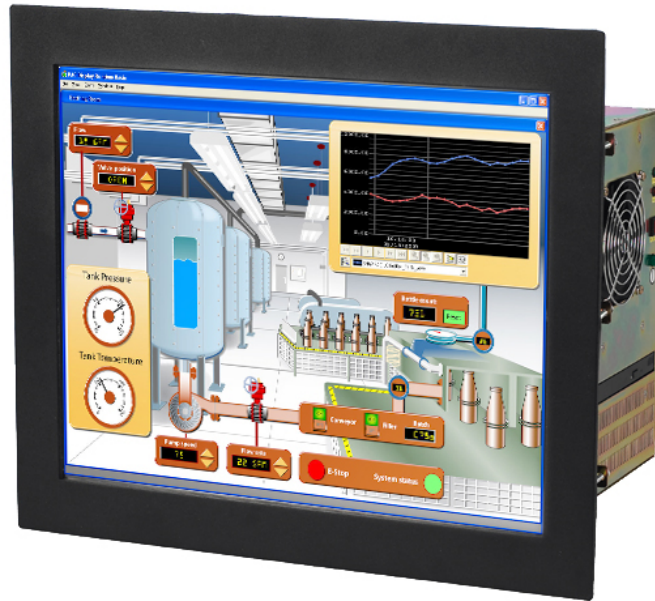

## USER'S MANUAL

Version 1.0  
06/12/12

TR-7FJ€INDUSTRIAL PANEL/RACK MOUNT PC  
WITH 15" TFT LCD TOUCH SCREEN  
WITH INTEL CORE i7 / i5 / i3 PROCESSORS

23-5155 Spectrum Way, Mississauga, ON, Canada L4W 5A1

TEL: 1-800-268-0427, 905-625-1907

F AX: 905-625-0531

Email: [sales@transduction.com](mailto:sales@transduction.com)

## **Table of Contents**

<b>Important Information</b> .....	<b>1</b>
<b>Recommended Use</b> .....	<b>2</b>
<b>Introduction</b> .....	<b>3</b>
Contents .....	4
TR-7190 Specifications .....	5-6
TR-6S2 Backplane .....	6
Touch Screen .....	7-15
<b>TR-999 SBC Introduction</b> .....	<b>17</b>
Product Description .....	18
TR-999 Specifications .....	19
Board Dimensions .....	20
<b>Installations</b> .....	<b>21</b>
Installing the CPU .....	22
Installing the Memory .....	23
Setting the Jumpers .....	24-28
Connectors on TR-999 .....	29-37
<b>BIOS Setup</b> .....	<b>39</b>
BIOS Introduction .....	40
BIOS Setup .....	40-41
Advanced Settings .....	42-53
Chipset Settings .....	54-57
Boot Settings .....	58
Security Settings .....	59
Save & Exit Settings .....	60-61

**TABLE OF CONTENTS**

---

**Drivers Installation .....63**

- Intel Chipset Software Installation Utility .....64
- VGA Drivers Installation .....65
- Realtek HD Audio Driver Installation .....66
- LAN Drivers Installation ..... 67-68
- Intel Management Engine Interface ..... 69-70

**Appendix .....71**

- I/O Port Address Map .....71
- Interrupt Request Line (IRQ) .....72
- Watchdog Timer Configuration ..... 73-75
- TR-7190 Mechanical Drawings .....76-91

*The information in this document is subject to change without notice.  
All relevant issues have been considered in the preparation of this document.  
Should you notice an omission or any questionable item in this document, please  
feel free to notify Transduction. Regardless of the foregoing statement,  
Transduction assumes no responsibility for any errors that may appear in this  
document nor for results obtained by the user as a result of using this product.*

**Copyright © 2012 Transduction. All rights reserved.**

*This document is protected by copyright. No part of this document may be  
reproduced, copied or translated in any form or means without prior written  
permission from Transduction. All other trademarks, brand and product names  
are the property of their respective owners.*

**Return policy**

*Products returned for repair must be accompanied by a Return Material  
Authorization (RMA) number, obtained from Transduction prior to return.  
Freight on all returned items must be prepaid by the customer. The customer is  
responsible for any loss or damage caused by the carrier in transit. To obtain an  
RMA number, call us at 905-625-1907. We will need the following information:*

- *Return company address and contract*
- *Model name, model number and serial number*
- *Description of the failure*

*Mark the RMA number clearly on the outside of each box, include a failure  
report*

*and return the product to:*

*Transduction  
5155 – 23 Spectrum Way  
Mississauga ON Canada L4W 5A1  
Attn: RMA Department*

### **Safety Precautions and Maintenance**



FOR OPTIMUM PERFORMANCE, PLEASE NOTE  
THE FOLLOWING WHEN SETTING UP  
AND USING THE **TR-7** :

- **DO NOT OPEN THE MONITOR.** There are no user serviceable parts inside and opening or removing covers may expose you to dangerous shock hazards or other risks. Refer all servicing to qualified service personnel.
- Do not spill any liquids into the cabinet or use your monitor near water.
- Do not insert objects of any kind into the cabinet slots, as they may touch dangerous voltage points, which can be harmful or fatal or may cause electric shock, fire or equipment failure.
- Do not place any heavy objects on the power cord. Damage to the cord may cause shock or fire.
- Do not place this product on a sloping or unstable cart, stand or table, as the monitor may fall, causing serious damage to the monitor.
- When operating the **TR-7** with its AC 125-240V power supply, use a power supply cord that matches the power supply voltage of the AC power outlet being used. The power supply cord you use must have been approved by and comply with the safety standards of your country. (Type H05VV-F should be used in Europe)
- In UK, use a BS-approved power cord with molded plug having a black (5A) fuse installed for use with this monitor. If a power cord is not supplied with this monitor, please contact your supplier.
- Do not place any objects onto the monitor and do not use outdoors.
- The inside of the fluorescent tube located within the LCD monitor contains mercury. Please follow the bylaws or rules of your municipality to dispose of the tube properly.

Immediately unplug your unit from the power source and refer servicing to qualified service personnel under the following conditions:

- When the power supply cord or plug is damaged.
- If liquid has been spilled, or objects have fallen into the unit.
- If the unit has been exposed to rain or water.
- If the unit has been dropped or the cabinet damaged.
- If the unit does not operate normally by following operating instructions.
- Do not bend power cord.
- Do not use in high temperature, humid, dusty, or oily areas.
- If glass is broken, handle with care.
- Do not cover vents on unit.
- If monitor or glass is broken, do not come in contact with the liquid crystal and handle with care.
- Allow adequate ventilation around the unit so that heat can properly dissipate. Do not block ventilated openings or place near a radiator or other heat sources.
- Handle with care when transporting. Save packaging for transporting.

## **Introduction**

This chapter is designed to give an overview of TR-7190 industrial PC. The topics covered in this chapter are as follows:

Contents .....	4
TR-7190 Specifications.....	5-6
TR-6S2 Backplane.....	6
Touch Screen.....	7-15

## Contents

Your new **TR-7** box\* should contain the following:

- **TR-7** PC/LCD
- Power Cord
- User's Manual
- CD-ROM with drivers

Power Cord



TR-7190 Panel/Rack Mount PC

User's Manual



Driver CD

*\*Remember to save your original box and packing material to transport or ship the monitor.*

## TR-7190 Specifications

<b>Model</b>	TR-7190 Industrial Panel Mount and Rack Mount Computer with Intel Core 1-series Processor 19" LCD Touch Screen
<b>Processor</b>	Intel Socket LGA1155 for Core i-series, i7, i5 and i3 processors up to 3.4GHz with 1066/1333MHz FSB with 62CFM PWM air fan
<b>LCD Display</b>	Resolution - 1280 x 1024 (XGA) Backlight MTBF 150,000 hours Brightness - 300cd/m <sup>2</sup> Contrast Ratio - 700:1 Resistive or capacitive touch screen
<b>Memory</b>	2 x 240 pin DIMM sockets, up to 16GB DDR3 memory, high temperature version
<b>Drive Bay</b>	2 x 3.5" HDD (RAID 1 Ok) or Flash SSD 1 x 5.25" SATA CD-DVD-R/W
<b>Expansion Slots (TR-6S2 Backplane)</b>	3 x PCI, 1 x PCIe x4 and 1 x PCIe x16
<b>Display</b>	Intel Graphic Engine interface, DB15 SVGA connector
<b>Ethernet</b>	2 x Intel 82579V/82583V on board for Dual Gigabit LAN
<b>Solid State Disk</b>	High speed flash SATA SSD 64GB ~ 512GB with bad block auto-correction
<b>I/O</b>	2 x Serial RS-232 3 x USB 2.0 2 x RJ-45 LAN 1 x LPT PS/2 keyboard/mouse connectors
<b>Watchdog Timer</b>	Generates system reset; 256 levels
<b>Cooling</b>	1 x CPU cooling fan connector near CPU socket 1 x system cooling fan connectors for chassis or power supply cooling
<b>Power</b>	Output rating - 300W Input Voltage - 100 ~ 240VAC @ 47/63Hz Optional DC input power - 12V, 24V, 48V, 125V and 250V MTBF 80,000 hours Electrical Safety Approval
<b>System Monitor</b>	Monitor processor temperature, system/CPU temperature and voltage status, also processor and system air fans
<b>Operating Temperature</b>	0° ~ 50°C (32° ~ 122°F) with hard drive 0° ~ 60°C (32° ~ 140°F) for 2 hours with SSD Relative Humidity: 5 ~ 95%

<b>Dimensions</b>	17.75" (W) x 15.25" (H) x 6.4" (D) (8.00" (D) behind front panel) Rack mount version is 8U high N.W. 32 lbs, G.W. 37 lbs, CUFT. 6
<b>Chassis Colour</b>	Black, OEM colour optional
<b>Warranty</b>	3 years or 10% initial cost for 5 years
<b>Additional Options</b>	9U rack mount version Rear access Floppy/CD option Wall mounting bracket High speed flash SATA SSD 64 ~ 512GB with bad block auto-correction SATA RAID 1 option up to 1TB 6 additional USB ports BNC IRIG A/B time sync option Safety glass in place of touch screen

## TR-6S2 Backplane

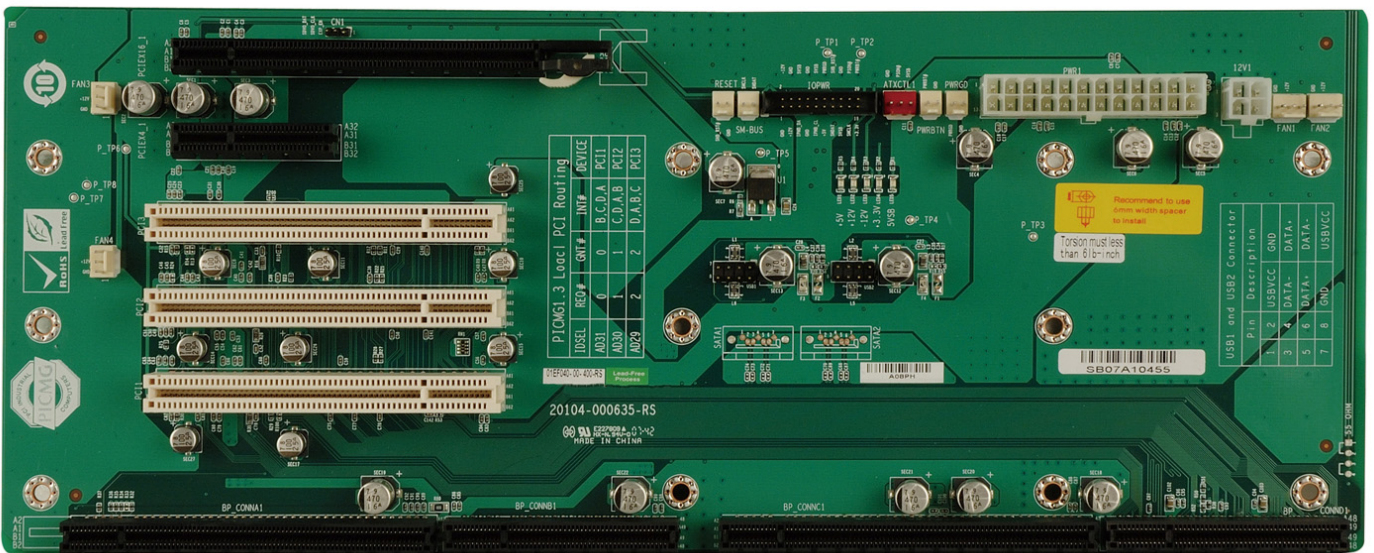

î È [ úóô õ è ì á ] ã ^ á ã ã á ú ó ô õ è ã ú ó ó á ì è ã á ú ó ó á ã ã ã á á ú ó ó á [ ì ó

# Touch Screen

## USB Controller Driver Installation

All Windows drivers are included on the Transduction **TR-7** 5-wire Touchscreen Drivers CD along with Troubleshooting.

**NOTE:** For Win XP and 2000 you **MUST** logon with administrator's password.

**TouchKit** software on the driver CD has the required drivers and the utility for toggling between left and right mouse buttons and configuration support. These will all be installed when Setup.exe is run from the CD.

### For Windows 2000/XP

When the New Hardware Found message comes up, choose **Cancel**. Run the **Setup.exe** program from the driver CD.

Please note that the touch screen controller in the TR-7190 is **USB** and follow the prompts accordingly.

Windows will copy the files to your hard drive and setup will be complete. (Windows XP will give a warning message about the TouchKit Controller certification, press **Continue** anyway.)

Please reboot your computer.

Windows will now find the device automatically and it will be listed in the Device Manager as: *TouchKit USB Controller*.

### TouchKit Software

There are five property pages:

1. **GENERAL:** Language selection, add/remove devices, 4-point Calibration, Draw Test and Advanced

#### 4 pts Cal

Choose to calibrate your screen by touching the blinking symbol on the panel until you get a beep or it stops blinking



**Draw Test**

Test the drawing position in relation to the display screen to verify panel linearity, calibration capability and drawing line quality.

**Advanced**

A 25 Point calibration utility for the touch sensor. Press **Clear** to clear previous calibration records. Press **25 pts Cal** to do 25 point calibration by touching the blinking symbol on the panel until you get a beep or it stops blinking. After calibration, the new record will overwrite the old one.



2. **SETTING:** Sound, Mouse Mode and Double Click Adjustment

**Sound**



### No Sound

Choose to make no sound when panel is touched.

### Touch Down

Beep will sound when panel is touched.

### Lift Up

The system will not make any sound until finger leaves the touch panel.

### Frequency

Sound frequency, drag the cursor from left to right = low to high.

### Duration

Sound duration, drag the cursor from left to right = short to long.

### Mouse Mode

The **Mouse Mode** provides users different operating options.

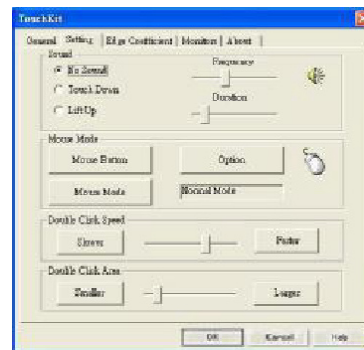

### Mouse Button

Click it to **show/hide Touch Tray** on the right bottom corner of the desktop.

Users can choose show or hide **Touch Tray** from the mouse icon in the taskbar.

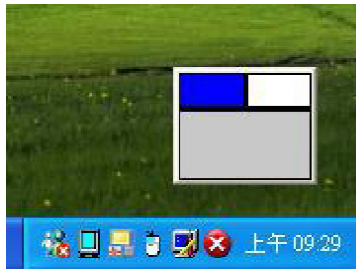

Change **right/left** button by clicking the upper small rectangular box of **Touch Tray**.

Blue area indicates which button has been selected.

### Shutdown utility



Click on shutdown utility in the task bar



Shutdown utility dialog

There are five modes in shutdown utility:

**[Standby]** to enter standby mode that saves power consumption.

**[Shutdown]** to turn off PC.

**[Reboot]** to restart PC.

**[Cancel]** to escape from the Shutdown utility dialog.

**[Exit]** to disable the Shutdown utility.

**Please note that Windows NT does not support this function.**

### Mouse Mode

There are three mouse modes:

**[Normal Mode]**

Provides all the mouse functions, including the dragging function.

**[Click on Touch]**

Click action is executed as soon as panel is touched.

**[Click on Release]**

Click action will not be executed until finger leaves the panel.

### Option

**Touchkit** provides an option for advanced Mouse Emulation setting.

When the **Option** button is pressed, a setting property sheet will pop up.

**Support Constant Touch** and **Support Auto Right Button** check boxes

are shown in the property sheet to

**enable/disable constant touch** and **Auto right button** support.

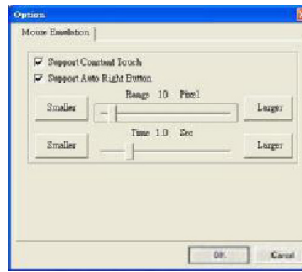

### Constant Touch

Enable **Constant Touch** to force driver to stop reporting touch points when movement is slight. You will see a stabilized cursor instead of a chattering cursor when users touch the same point. Eliminates unwanted noise.

### Auto Right Button

Enable **Auto Right Button** to force driver to report a **right click mouse event** to OS when users lift up from a **constant touch**. You no longer need to touch the **right button** in the touchtray to activate a right click. This makes it easier to right click.

### Cursor Visibility

Cursor visibility function allows the cursor to be hidden. Go to **Start / Control Panel / Mouse / Pointers / Scheme**, and choose **TouchKit Hide Cursor**. Press **[Apply]** to make the setting change, and press **[OK]** to escape the property page.

### Double Click Adjustment

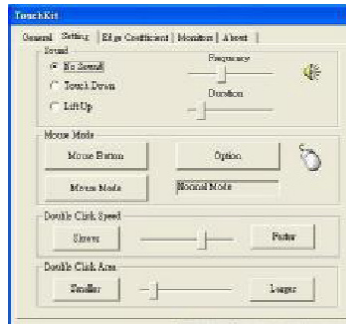

**Double Click Speed**

Double Click Speed is the double click response time for the Windows system. Users can adjust the speed for easy double click by touch panel.

**Double Click Area**

Each individual touch has its own touch tolerance. If the Double Click Area is set to **<Smaller>**, the panel will be very sensitive about micro-movements when you want to fix on a point. If set to **<Larger>**, larger touch point movement is tolerated when you want to point at a fixed position.

**3. EDGE COEFFICIENT:** Edge compensation for Top, Bottom, Left, Right, X Axis and Y Axis

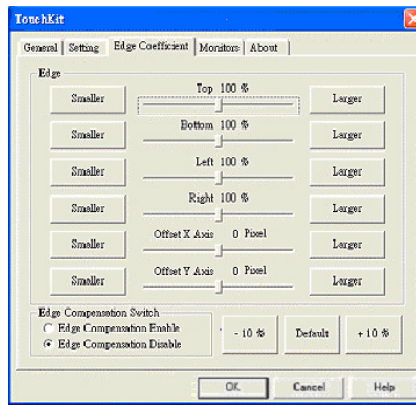

If it is difficult to touch items at the edges of the touch panel, you can adjust the edges of the screen image.

**Top**

If you set the Edge to **<Smaller>**, TouchKit will reduce the horizontal position of the top edge. If you set the Edge to **<Larger>**, TouchKit will extend the horizontal position of the top edge.

### Bottom

If you set the Edge to **<Smaller>**, TouchKit will reduce the horizontal position of the bottom edge. If you set the Edge to **<Larger>**, TouchKit will extend the horizontal position of the bottom edge.

### Left

If you set the Edge to **<Smaller>**, TouchKit will reduce the vertical position of the left edge. If you set the Edge to **<Larger>**, TouchKit will extend the vertical position of the left edge.

### Right

If you set the Edge to **<Smaller>**, TouchKit will reduce the vertical position of the right edge. If you set the Edge to **<Larger>**, TouchKit will extend the vertical position of the right edge.

In some cases, the cursor will be behind the finger when you touch the panel. If you cannot see the cursor, you can set the X Axis or Y Axis to move the cursor.

### Offset X Axis

If you set the Offset X Axis to **<Smaller>**, cursor will be moved one pixel to the left of the X Axis. If you set the Offset X Axis to **<Larger>**, cursor will be moved one pixel to the right of the X Axis.

### Offset Y Axis

If you set the Offset Y Axis to **<Smaller>**, cursor will be moved one pixel above the Y Axis. If you set the Offset Y Axis to **<Larger>**, cursor will be moved one pixel below the Y Axis.

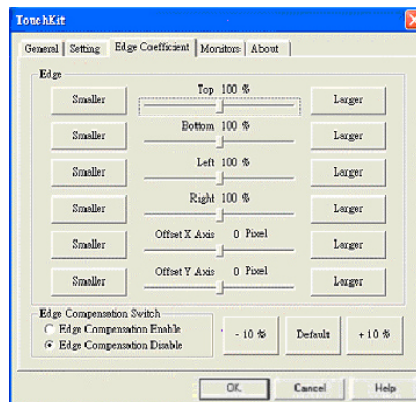

### Edge Compensation Switch

Use the **+10%** and **-10%** button to adjust. If you press the **+10%** button, the top, bottom, left and right edges will extend 10%, and the cursor will be moved 10 pixels from the X and Y Axis to the right and top. If you press the **-10%** button, the top, bottom, left and right edges will contract 10%, and cursor will be moved 10 pixels from the X and Y Axis to the left and bottom.

Choose the **Default** button to restore the default settings.

## 4. MONITORS: Multiple Monitors, Split Monitor

### Multiple Monitors

To configure the mapping relationship between the monitors and the touch panels, select the monitor page as below.

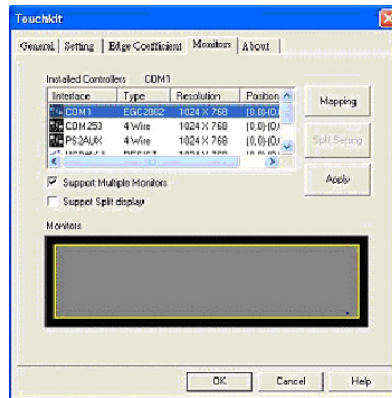

Set the check box (Use Multiple Monitors) to enable multiple monitors mapping. Unchecking this box will disable multiple-monitor configuration, and all of the touch panel controllers will be mapped to the primary monitor. The gray shadow area is the monitor mapped to the selected controller/panel. The button **[Mapping]** is used to find the mapping relationships between the monitors and touch panel controllers. Press **[Mapping]** and the software will guide you to touch the corresponding monitor to obtain the mapping relationship.



After completing monitor mapping, Press **[Apply]** to apply the mapping relationship.

### Split Monitors

To use the Split Monitor function, you need to select which controller you want to launch this function, then check the Multiple Monitors box and Split Monitor at the same time as shown below. Press the **[Split Monitor]** button to set up the active area.

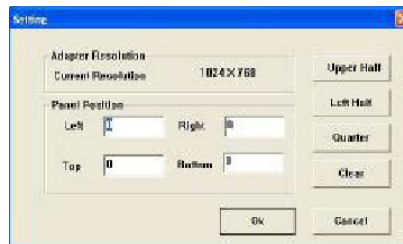

It shows the current resolution of the display and you can set the active area by inputting the value or use the default button **[Upper Half]**, **[Left Half]** or **[Quarter]**. The default value of panel resolution should be full screen as Left: **0**, Right: **0**, Top: **0** and Bottom: **0**.

5. **ABOUT:** General information about TouchKit.

### Uninstalling TouchKit

To uninstall, use the TouchKit/Uninstall from the Programs menu on the Start button.

---

*This page is intentionally left blank.*

## **TR-999 SBC Introduction**

This chapter describes the TR-7001 single board computer, TR-999. The topics covered in this chapter are as follows:

Product Description .....	18
TR-999 Specifications.....	19
Board Dimensions.....	20

## **TR-999 SBC Introduction**

### **Product Description**

---

---

The TR-999 PICMG 1.3 SHB Express CPU Card is based on the latest Intel® Q67 chipset. The platform supports 3<sup>rd</sup> generation Intel® Core processor family with LGA1155 packing and features an integrated dual-channel DDR3 memory controller as well as a graphics core.

The latest Intel® processors provide advanced performance in both computing and graphics quality. This meets the requirement of customers in the gaming, POS, digital signage and server market segment.

The Q67 platform is made with 32-nanometer technology that supports Intel's first processor architecture to unite the CPU and the graphics core on the transistor level. The TR-999 SHB board utilizes the dramatic increase in performance provided this Intel's latest cutting-edge technology. Dimensions of the board are 338mm x 126mm.

### **VÜEJJÁFEATURES:**

- Supports Intel® 3rd Generation Core i7/i5/i3 QC/DC desktop processors
- Two DDR3 DIMM, 1066/1333MHz, Max. 16GB memory
- Dual Intel® PCI-Express Gigabit LAN
- Integrated Graphics for CRT, DVI-I, LVDS displays
- 2x SATA 2.0, 2x SATA 3.0, 9x USB 2.0, 2x COM, Watchdog timer
- 2x SATA 2.0, 4x USB 2.0 for PICMG 1.3 backplane
- 1x PCI-E (x16), 1x PCI-E (x4), 4x PCI for PICMG 1.3 backplane

## VT/;; ; Specifications

<b>Product Name</b>	<b>TR-999</b>
<b>Form Factor</b>	PICMG 1.3 SHB Express full size CPU card
<b>CPU Type</b>	- Intel® Sandy Bridge 32nm QC/DC DT processor w/ IMC & Gfx - LGA package[37.5 mm x 37.5mm](TDP: QC= 95W/65W ; DC = 65W) **Sandy Bridge-DT is <b>NOT</b> socket compatible with Clarkdale/Lynnfield
<b>CPU Speed</b>	Up to 3.1GHz
<b>Cache</b>	Up to 8MB
<b>CPU Socket</b>	<b>LGA1155 (Socket H2)</b>
<b>Chipset</b>	Intel® Q67 PCH 27 x 27 mm package size
<b>BIOS</b>	AMI BIOS, support ACPI Function
<b>Memory</b>	Intel® Core™ i7/i5/i3 DT processor integrated memory controller DDR3 1066/1333 MHz (Non-ECC) DIMM x 2, Max. 16GB
<b>VGA</b>	- Intel® 3 <sup>rd</sup> generation Core™ i7/i5/i3 mobile processor integrated Gfx <ul style="list-style-type: none"> <li>• VGA</li> <li>• DVI-D X 1 (thru Level shifter ASM1442)</li> <li>• LVDS : 24-bit dual channel (Chrontel CH7308 via SDVO)</li> </ul>
<b>LAN</b>	1. Intel® Q67 Gigabit MAC + PHY :Intel® 82579V GbE x1 2. Intel® 82583V PCI-e Gigabit LAN controller x1
<b>USB</b>	Intel® Q67 built-in USB 2.0 host controller, support <b>14</b> ports <b>10 ports on SHB, 4 ports to the backplane [Connector C]</b>
<b>Serial ATA</b>	Intel® Q67 PCH built-in SATA controller, supports total 6 ports 2 x SATA (3.0) 6Gbps+ 4 x SATA (2.0) 3Gbps ports <b>[2 x SATA 2.0 ports to the backplane Connector C]</b>
<b>Audio</b>	Intel® Q67 built-in high definition audio w/ Realtek ALC662 Codec
<b>LPC I/O</b>	Winbond W83627DHG-P COM1 (RS232 only), COM2 (RS232/422/485) Hardware Monitor (2 thermal inputs, 4 voltage monitor inputs & 3 Fan headers) 4 Pin PWM_Fan x 1+3 Pin_DC_Fan x2
<b>Digital IO</b>	4 in & 4 out
<b>KB/Mouse</b>	Supports PS/2 Keyboard/Mouse connector [KB 1 <sup>st</sup> priority]
<b>Expansion Slots</b>	Mini PCI-express socket x1@solder side [Full-sized]; [Support USB client]
<b>Edge Connectors</b>	PS/2 Connector x1 for keyboard/mouse DB15 for VGA, 2x RJ45 for LAN 1 & 2, 1x USB 2.0
<b>Interface</b>	1x PCIe (16x) [Connector A & B] 4x PCIe (1x) or 1x PCIe (4x) [Connector A] 4x PCI masters [Connector D]
<b>Onboard Header/ Connector</b>	2x DF13 for 24-bit LVDS 1x 4-pin box header for brightness control 1x DF11-20-pin header for DVI 2x13 pins box-header x1 for Printer 2x DF11-10-pin box-header for COM1/ COM2 4x 8-pin header for USB1-8 1x 12-pin header for Audio (Line-Out, Line-In & Mic) <b>1x 10-pin header Digital I/O</b> 1x 4-pin header for CPU fan (PWM smart fan) 1x 3-pin x2 header for system fan (DC-fan) 6x SATA (Black connectors x4 for SATA2; Blue connectors x2 for SATA 3) 1x 10-pin header Front panel
<b>Watchdog Timer</b>	Yes (256 segments, 0, 1, 2,...255 sec/min)
<b>System Voltage</b>	ATX
<b>Others</b>	LAN Wakeup
<b>Board Size</b>	338mm x 126mm

## Board Dimensions

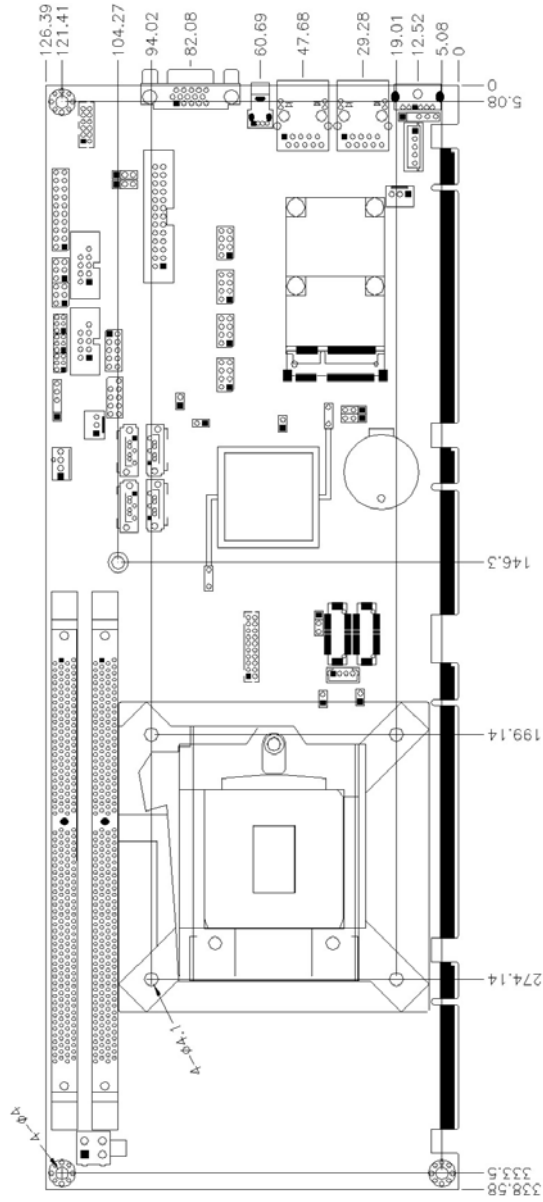

## **Installations**

This section provides information on how to use the jumpers and connectors on the TR-999 in order to set up a workable system. The topics covered are:

Installing the CPU .....	22
Installing the Memory .....	23
Setting the Jumpers.....	24-28
Connectors on TR-999.....	29-37

---

## Installing the CPU

---

The TR-999 board supports an LGA1155 Socket (shown below) for Intel Sandy Bridge processors.

To install the CPU, unlock first the socket by pressing the lever sideways, then lift it up to a 90-degree. Then, position the CPU above the socket such that the CPU corner aligns with the gold triangle matching the socket corner with a small triangle. Carefully insert the CPU into the socket and push down the lever to secure the CPU. Then, install the heat sink and fan.

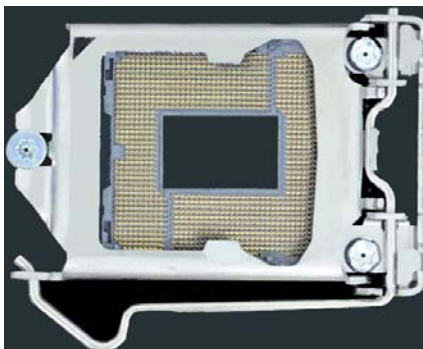

**NOTE:** Ensure that the CPU heat sink and the CPU top surface are in total contact to avoid CPU overheating problem that would cause your system to hang or be unstable.

---

## Installing the Memory

---

The TR-999 board supports two DDR3 memory socket for a maximum total memory of 16GB in DDR3 DIMM memory type.

### Installing and Removing Memory Modules

To install the DDR3 modules, locate the memory slot on the board and perform the following steps:

1. Hold the DDR3 module so that the key of the DDR3 module aligned with that on the memory slot.
2. Gently push the DDR3 module in an upright position until the clips of the slot close to hold the DDR3 module in place when the DDR3 module touches the bottom of the slot.
3. To remove the DDR3 module, press the clips with both hands.

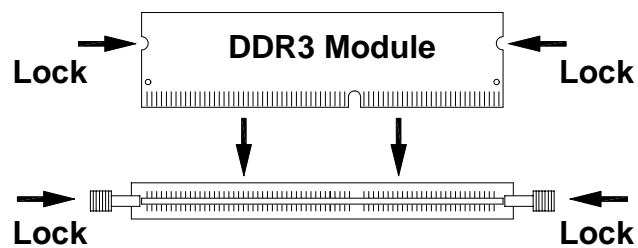

## Setting the Jumpers

---

Jumpers are used on TR-999 to select various settings and features according to your needs and applications. Contact Transduction if you have doubts about the best configuration for your needs. The following lists the connectors on TR-999 and their respective functions.

Jumper Locations on TR-999 .....	25
JP1, JP2, JP3: RS232/RS422/RS485 (COM2) Selection.....	26
JP4: COM2 RS232 RI/+5V/+12V Power Setting.....	26
JP5: COM1 RS232 RI/+5V/+12V Power Setting.....	26
JP7: ME TLS DISABLE/ENABLE (Factory use only).....	26
JP8: Flash Descriptor Security Override (Factory use only) .....	27
JP9: LVDS Panel Power Select .....	27
JP10: Backlight Adjust .....	27
JP11: PWM voltage setting(Factory use only) .....	27
JP12: SRTC RST#(Factory use only).....	27
JP13: Backlight Enable.....	28
JP14: ATX or AT (Emulation) Mode Selection .....	28
JBAT1: Clear CMOS Contents.....	28

Jumper Locations on TR-999

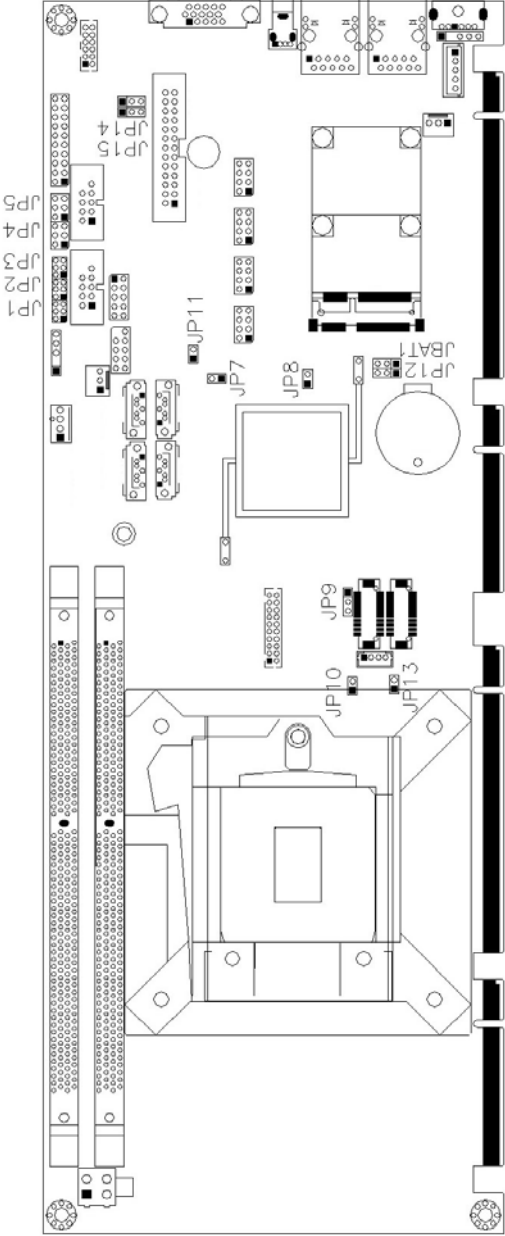

**JP1, JP2, JP3: RS232/RS422/RS485 (COM2) Selection**

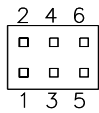

COM2 Function	RS-232	RS-422	RS-485
Jumper Setting (Pin closed)	JP1: 1-2	JP1: 3-4	JP1: 5-6
	JP2: 3-5&4-6	JP2: 1-3&2-4	JP2: 1-3&2-4
	JP3: 3-5&4-6	JP3: 1-3&2-4	JP3: 1-3 & 2-4

**JP4: COM2 RS232 RI/+5V/+12V Power Setting**

JP4	Setting	Function
	Pin 1-2 Short/Closed	+12V
	Pin 3-4 Short/Closed	RI
	Pin 5-6 Short/Closed	+5V

Note: The suggested setting is RI, with maximum current lower than 1A.

**JP5: COM1 RS232 RI/+5V/+12V Power Setting**

JP5	Setting	Function
	Pin 1-2 Short/Closed	+12V
	Pin 3-4 Short/Closed	RI
	Pin 5-6 Short/Closed	+5V

Note: The suggested setting is RI, with maximum current lower than 1A.



**JP7: ME TLS DISABLE/ENABLE (Factory use only)**

JP7	ME TLS Disable/Enable
Open	Disabled (Default)
Close	Enabled



**JP8: Flash Descriptor Security Override (Factory use only)**

JP8	Flash Descriptor Security Override
Open	Disabled (Default)
Close	Enabled

**JP9: LVDS Panel Power Select**



JP9	Setting	Panel Voltage
	Pin 1-2 Short/Closed	3.3V (default)
	Pin 2-3 Short/Closed	5V

**JP10: Backlight Adjust**

JP10	Setting	Panel Voltage
	OPEN	3.3V (default)
	CLOSE	5V

**JP11: PWM voltage setting(Factory use only)**



**JP12: SRTC RST#(Factory use only)**

JP12	Setting	Function
	Pin 1-2 Short/Closed (Default)	Normal
	Pin 2-3 Short/Closed	Clear ME

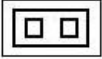
**JP13: Backlight Enable**

JP13	Setting	Panel Voltage
	OPEN	3.3V (default)
	CLOSE	5V



**JP14: ATX or AT (Emulation) Mode Selection**

JP14	Setting
	AT (Emulation)
	ATX

1-2: AT (Emulation), for SYS PWR\_ON. Automatic power on comes after a 200ms delay.

2-3: ATX Mode, SYS PWR\_ON for manual control

**JBAT1: Clear CMOS Contents**

JBAT1	Setting	Function
	Pin 1-2 Short/Closed	Normal
	Pin 2-3 Short/Closed	Clear CMOS

---

**Connectors on TR-999**

---

Connector Locations on TR-999 .....	30
CN1: ATX 12V Power Connector .....	31
CN2.CN4: SATA 3.0 Connectors(Blue) .....	31
CN6: DB-15 VGA Connector .....	31
CN7: USB2.0 Connector .....	31
CN8: Gigabit LAN (Intel 82579V) .....	31
CN9: Gigabit LAN (Intel 82583V) .....	31
CN10: PS/2 Keyboard and Mouse Connector .....	31
J2: Front Panel Function.....	32
J8: SPI Flash (Factory use only).....	33
J9: Digital I/O Port .....	33
J10: Parallel Port.....	33
J11: USB 2/3 Ports .....	34
J12: USB 6/7 Ports .....	34
J13: USB 4/5 Ports .....	34
J14: USB 8/9 Ports .....	34
J15: DVI-D Port .....	35
J17: Mini PCIE Connector .....	35
J18: LCD Backlight Control.....	35
J19: External PS/2 Keyboard Port.....	35
J20: External PS/2 Mouse Port.....	36
J21, J22: LVDS Connector (2nd channel, 1st channel).....	36
J23: External Audio Connector .....	37
CPU_FAN0: CPU Fan0 Power Connector.....	37
CPU_FAN1: CPU Fan1 Power Connector.....	37
SYS_FAN1: System Fan1 Power Connector .....	37

Connector Locations on TR-999

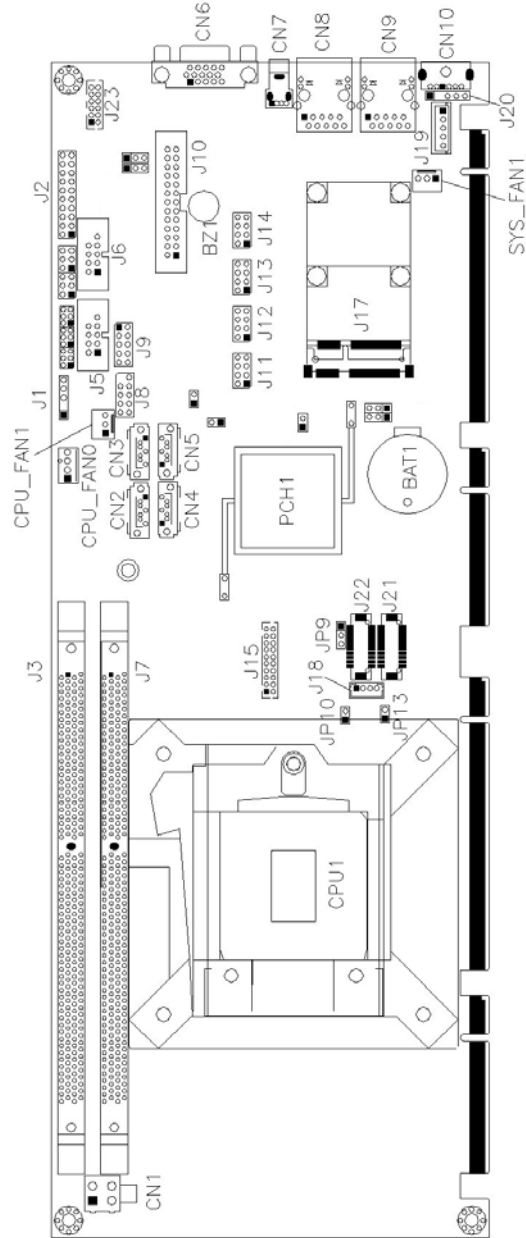

**CN1: ATX 12V Power Connector**

This connector supplies the CPU operating voltage.

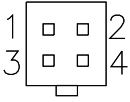

Pin #	Signal Name
1	Ground
2	Ground
3	+12V
4	+12V

**CN2.CN4: SATA 3.0 Connectors(Blue)**

**CN3.CN5: SATA 2.0 Connectors(Black)**

**CN6: DB-15 VGA Connector**

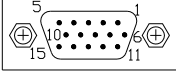

Signal Name	Pin #	Pin #	Signal Name
Red 1		2	Green
Blue 3		4	N.C.
GND 5		6	GND
GND 7		8	GND
VCC 9		10	GND
N.C. 11		12	DDCDATA
HSYNC 13		14	VSYNC
DDCCLK 15			

**CN7: USB2.0 Connector**

**CN8: Gigabit LAN (Intel 82579V)**

**CN9: Gigabit LAN (Intel 82583V)**

This RJ45 LAN connector features for LAN wakeup.

**CN10: PS/2 Keyboard and Mouse Connector**

CN10 uses a Y-cable with dual D-connectors.

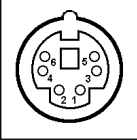

Pin #	Signal Name
1	Key board Data
2	ouse Data
3	Ground
4	Vcc
5	Key board Clock
6	ouse Clock

**J2: Front Panel Function**



Signal Name	Pin #	Pin #	Signal Name
Speaker out	1	2	PWR LED +
No connect	3 4		No connect
GND	5	6	GND
+5V	7 8		NC
No connect	9 10		GND
No connect	11 12		GND
PWR_SW	13	14	PWR_SW
No connect	15 16		No connect
RST	17	18	GND
HDD LED -	19	20	HDD LED +

**J3: DDR3 DIMM Socket Channel B**

**J7: DDR3 DIMM Socket Channel A**

**J5: COM2 Serial Port(RS232/422/485)**

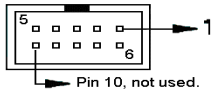

Please refer to JP1, JP2, JP3: RS232/422/485 (COM2) Selection

Pin #	Signal Name		
	RS-232	R2-422	RS-485
1 DCD		TX-	DATA-
2 RX		TX+	DATA+
3 TX		RX+	NC
4 DTR		RX-	NC
5 Ground		Ground	Ground
6 DSR		RTS-	NC
7 RTS		RTS+	NC
8 CTS		CTS+	NC
9 RI		CTS-	NC
10 NC		NC	NC

**J6: COM1 Serial Port(RS232)**

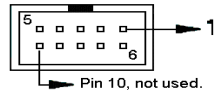

**J8: SPI Flash (Factory use only)**

**J9: Digital I/O Port**

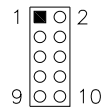

Signal Name	Pin	Pin	Signal Name
GND 1		2	VCC
OUT3 3		4	OUT1
OUT2 5		6	OUT0
IN3 7		8	IN1
IN2 9		10	IN0

**J10: Parallel Port**

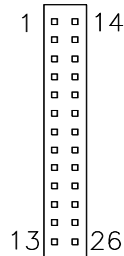

Signal Name	Pin #	Pin #	Signal Name
Line printer strobe	1	14	AutoFeed
PD0, parallel data 0	2	15	Error
PD1, parallel data 1	3	16	Initialize
PD2, parallel data 2	4	17	Select
PD3, parallel data 3	5	18	Ground
PD4, parallel data 4	6	19	Ground
PD5, parallel data 5	7	20	Ground
PD6, parallel data 6	8	21	Ground
PD7, parallel data 7	9	22	Ground
ACK, acknowledge	10	23	Ground
Busy 11		24	Ground
Paper empty	12	25	Ground
Select 13		26	Ground

**J11: USB 2/3 Ports**

The following table shows the pin outs of the USB2.0 pin header.

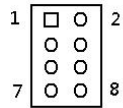

Signal Name	Pin	Pin	Signal Name
Vcc 1		2	Ground
USB2- 3		4	USB3+
USB2+ 5		6	USB3-
Ground 7		8	Vcc

**J12: USB 6/7 Ports**

The following table shows the pin outs of the USB2.0 pin header

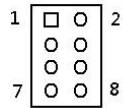

Signal Name	Pin	Pin	Signal Name
Vcc 1		2	Ground
USB6- 3		4	USB7+
USB6+ 5		6	USB7-
Ground 7		8	Vcc

**J13: USB 4/5 Ports**

The following table shows the pin outs of the USB2.0 pin header

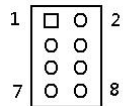

Signal Name	Pin	Pin	Signal Name
Vcc 1		2	Ground
USB4- 3		4	USB5+
USB4+ 5		6	USB5-
Ground 7		8	Vcc

**J14: USB 8/9 Ports**

The following table shows the pin outs of the USB2.0 pin header

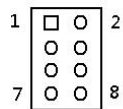

Signal Name	Pin	Pin	Signal Name
Vcc 1		2	Ground
USB8- 3		4	USB9+
USB8+ 5		6	USB9-
Ground 7		8	Vcc

**J15: DVI-D Port**

J15 is a 20-pin header that is used to connect to the optional DVI-D cable.

The following table shows the pin outs of the DVI-D pin header.

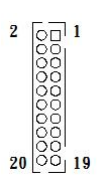

Signal Name	Pin #	Pin #	Signal Name
TDC1#_B 2		1	TDC1_B
Ground 4		3	Ground
TLC#_B 6		5	TLC_B
5V 8		7	Ground
N.C. 10		9	HPDET_B
TDC2#_B 12		11	TDC2_B
Ground 14		13	Ground
TDC0#_B 16		15	TDC0_B
N.C. 18		17 N.C	.
SC_DDC_B 20		19	SD_DDC_B

**J17: Mini PCIE Connector**

**J18: LCD Backlight Control**

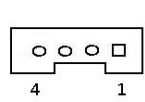

Pin #	Signal Name
1 +1.2V	
2 B	acklight Enable
3 B	acklight Adj
4 GND	

**J19: External PS/2 Keyboard Port**

The following table shows the pin outs of the PS/2 keyboard pin header.

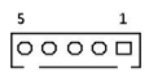

Pin #	J19
1 KB	clock
2 KB	data
3 N.C	.
4 Ground	
5 Vcc	

**J20: External PS/2 Mouse Port**

The following table shows the pin outs of the PS/2 mouse pin header.

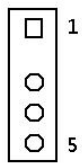

Pin #	J20
1 M	ouse data
2 N.C	
3 GND.	
4 M	ouse clock
5 Vcc	

**J21, J22: LVDS Connector (2nd channel, 1st channel)**

The LVDS connectors, DF13 20-pin mating connectors, are composed of the 2nd channel (J21) and 1st channel (J22) to support 18-bit or 24bit J22: first channel

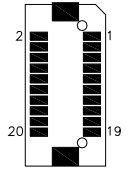

Signal Name	Pin #	Pin #	Signal Name
TX0- 2		1	TX0+
Ground 4		3	Ground
TX1- 6		5	TX1+
*5V/3.3V 8		7	Ground
TX3- 10		9	TX3+
TX2- 12		11	TX2+
Ground 14		13	Ground
TXC1- 16		15	TXC1+
*5V/3.3V 18		17	BKL_EN
+12V 20		19	+12V

\*JP9 can be used to set 3.3V or 5V.

J21: Second channel

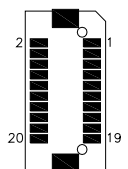

Signal Name	Pin #	Pin #	Signal Name
TX4- 2		1	TX4+
Ground 4		3	Ground
TX5- 6		5	TX5+
*5V/3.3V 8		7	Ground
TX7- 10		9	TX7+
TX6- 12		11	TX6+
Ground 14		13	Ground
TXC2- 16		15	TXC2+
*5V/3.3V 18		17	BKL_EN
+12V 20		19	+12V

\*JP9 can be used to set 3.3V or 5V.

**J23: External Audio Connector**

J23 is a 12-pin header that is used to connect to the optional audio cable.

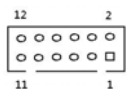

Signal Name	Pin #	Pin #	Signal Name
LINE OUT_L	1	2	LINE OUT_R
JD FRONT 3		4	Ground
LINE IN_L	5	6	LINE IN_R
JD LINE IN	7	8	Ground
MIC-L 9		10	MIC-R
JD MIC1	11	12	Ground

**CPU\_FAN0: CPU Fan0 Power Connector**

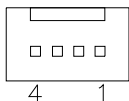

Pin #	Signal Name
1	Ground
2	+12V
3	Rotation detection
4	Control

Note: CPU\_FAN0 for PWM FAN mode

**CPU\_FAN1: CPU Fan1 Power Connector**

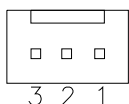

Pin #	Signal Name
1	Ground
2	+12V
3	Rotation detection

Note: CPU\_FAN0 for DC FAN mode

**SYS\_FAN1: System Fan1 Power Connector**

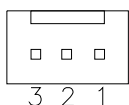

Pin #	Signal Name
1	Ground
2	+12V
3	NC

Note: SYS\_FAN1 for DC FAN mode

This page is intentionally left blank.

## **BIOS Setup**

This chapter describes the different settings available in the AMI BIOS that comes with the board. The topics covered in this chapter are as follows:

BIOS Introduction .....	40
BIOS Setup .....	40-41
Advanced Settings .....	42-43
Chipset Settings .....	54-57
Boot Settings .....	58
Security Settings .....	59
Save & Exit Settings .....	60-61

## BIOS Introduction

The BIOS (Basic Input/Output System) installed in your computer system's ROM supports Intel processors. The BIOS provides critical low-level support for a standard device such as disk drives, serial ports and parallel ports. It also provides password protection as well as special support for detailed fine-tuning of the chipset controlling the entire system.

## BIOS Setup

The BIOS provides a Setup utility program for specifying the system configurations and settings. The BIOS ROM of the system stores the Setup utility. When you turn on the computer, the BIOS is immediately activated. Pressing the <Del> key immediately allows you to enter the Setup utility. If you are a little bit late pressing the <Del> key, POST (Power On Self Test) will continue with its test routines, thus preventing you from invoking the Setup. If you still wish to enter Setup, restart the system by pressing the "Reset" button or simultaneously pressing the <Ctrl>, <Alt> and <Delete> keys. You can also restart by turning the system Off and back On again. The following message will appear on the screen:

Press <DEL> to Enter Setup

In general, you press the arrow keys to highlight items, <Enter> to select, the <PgUp> and <PgDn> keys to change entries, <F1> for help and <Esc> to quit.

When you enter the Setup utility, the Main Menu screen will appear on the screen. The Main Menu allows you to select from various setup functions and exit choices.

**Warning:** *It is strongly recommended that you avoid making any changes to the chipset defaults. These defaults have been carefully chosen by both AMI and your system manufacturer to provide the absolute maximum performance and reliability. Changing the defaults could cause the system to become unstable and crash in some cases.*

**System Language**

Choose the system default language.

**System Date**

Set the Date. Use Tab to switch between Data elements.

**System Time**

Set the Time. Use Tab to switch between Data elements.

## Advanced Settings

This section allows you to configure and improve your system and allows you to set up some system features according to your preference.

Aptio Setup Utility					
Main	Advanced	Chipset	Boot	Security	Save & Exit
	Legacy OpROM Support				
	Launch PXE OpROM			Disabled	
	Launch Storage OpROM			Enabled	
	▶ ACPI Settings				
	▶ Wake up event setting				
	▶ CPU Configuration				
	▶ SATA Configuration				
	▶ Shutdown Temperature Configuration				
	▶ PCI IRQ Configuration				
	▶ Intel IGD SWSCI OpRegion				→ ← Select Screen
	▶ USB Configuration				↑ ↓ Select Item
	▶ Super IO Configuration				Enter: Select
	▶ H/W Monitor				+ - Change Field
					F1: General Help
					F2: Previous Values
					F3: Optimized Default
					F4: Save ESC: Exit

### Launch PXE OpROM

Enable or Disable Boot Option for Legacy Network Devices.

### Launch Storage OpROM

Enable or Disable Boot Option for Legacy Mass Storage Devices with Option ROM.

## ACPI Settings

Aptio Setup Utility

Main	Advanced	Chipset	Boot	Security	Save & Exit
	Enable ACPI Auto Configuration		Disabled		
	Enable Hibernation		Enabled		→ ← Select Screen
	ACPI Sleep State		S1 (CPU stop clock)		↑ ↓ Select Item
	Lock Legacy Resources		Disabled		Enter: Select
					+ - Change Field
					F1: General Help
					F2: Previous Values
					F3: Optimized Default
					F4: Save ESC: Exit

### Enabled ACPI Auto Configuration

Enables or Disables BIOS ACPI Auto Configuration.

### Enable Hibernation

Enables or Disables System ability to Hibernate (OS/S4 Sleep State). This option may be not effective with some OS.

### ACPI Sleep State

Select the highest ACPI sleep state the system will enter, when the SUSPEND button is pressed.

### Lock Legacy Resources

Enabled or Disabled Lock of Legacy Resources.

**Wake up event settings**

Aptio Setup Utility

Main	Advanced	Chipset	Boot	Security	Save & Exit
	Wake system with Fixed Time		Disabled		
	Wake up hour		0		→ ← Select Screen
	Wake up minute		0		↑ ↓ Select Item
	Wake up second		0		Enter: Select
	Wake on Ring		Disabled		+ - Change Field
	Wake on PCI PME		Disabled		F1: General Help
	Wake on PCIE Wake Event		Disabled		F2: Previous Values
					F3: Optimized Default
					F4: Save ESC: Exit

**Wake system with Fixed Time**

Enables or Disables System wake on alarm event. When enabled, System will wake on the hr::min:: sec specified.

**Wake on Ring**

The options are Disabled and Enabled.

**Wake on PCI PME**

The options are Disabled and Enabled.

**Wake on PCIE PME Wake Event**

The options are Disabled and Enabled.

### CPU Configuration

This section shows the CPU configuration parameters.

Aptio Setup Utility					
Main	Advanced	Chipset	Boot	Security	Save & Exit
CPU Configuration					
Intel® Core™ i5-2400 CPU @ 3.10GHz					
Processor Stepping		206a7			
Microcode Revision		d			
Processor Speed		3100 MHz			
Processor Cores		4			
Intel HT Technology		Not Supported			
EMT64		Supported			
Hyper-threading		Enabled			
Active Processor Cores		All		→ ← Select Screen	
Limit CPUID Maximum		Disabled		↑ ↓ Select Item	
Execute Disable Bit		Enabled		Enter: Select	
Hardware Prefetcher		Enabled		+- Change Field	
Adjacent Cache Line Prefetch		Enabled		F1: General Help	
Intel Virtualization Technology		Disabled		F2: Previous Values	
Power Technology		Energy Efficient		F3: Optimized Default	
Local x2APIC		Disabled		F4: Save ESC: Exit	

#### Hyper-threading

Enabled for Windows XP and Linux (OS optimized for Hyper-Threading Technology) and Disabled for other OS (OS not optimized for Hyper-Threading Technology). When Disabled, only one thread per enabled core is enabled.

#### Active Processor Cores

Number of cores to enable in each processor package.

#### Limit CPUID Maximum

Disabled for Windows XP.

#### Execute Disable Bit

XD can prevent certain classes of malicious buffer overflow attacks when combined with a supporting OS (Windows Server 2003 SP1, Windows XP SP2, SuSE Linux 9.2, Red Hat Enterprise 3 Update 3.)

#### Hardware Prefetcher

To turn on/off the MLC streamer prefetcher.

**Adjacent Cache Line Prefetch**

To turn on/off prefetching of adjacent cache lines.

**Intel Virtualization Technology**

When enabled, a VMM can utilize the additional hardware capabilities provided by Vanderpool Technology.

**Power Technology**

Enable the power management features.

**Local x2APIC**

Enable Local x2APIC. Some OSes do not support this.

**SATA Configuration**

SATA Devices Configuration.

Aptio Setup Utility					
Main	Advanced	Chipset	Boot	Security	Save & Exit
SATA Configuration					
SATA Mode		IDE Mode		→ ← Select Screen	
Serial-ATA Controller 0		Compatible		↑ ↓ Select Item	
Serial-ATA Controller 1		Enhanced		Enter: Select	
SATA Port0		Not Present		+- Change Field	
SATA Port1		Not Present		F1: General Help	
SATA Port2		Not Present		F2: Previous Values	
SATA Port3		Not Present		F3: Optimized Default	
SATA Port4		Not Present		F4: Save ESC: Exit	
SATA Port5		Not Present			

**SATA Mode**

- (1) IDE Mode.
- (2) AHCI Mode.
- (3) RAID Mode.

**Serial-ATA Controller**

Enable / Disable Serial ATA Controller.

**Shutdown Temperature Configuration**

Aptio Setup Utility

Main	Advanced	Chipset	Boot	Security	Save & Exit
	ACPI Shutdown Temperature		Disabled		→ ← Select Screen ↑ ↓ Select Item Enter: Select +- Change Field F1: General Help F2: Previous Values F3: Optimized Default F4: Save ESC: Exit

**ACPI Shutdown Temperature**

The default setting is Disabled.

**PCI IRQ Configuration**

Aptio Setup Utility					
Main	Advanced	Chipset	Boot	Security	Save & Exit
			PCI/ISA		→ ← Select Screen
			PCI/ISA		↑ ↓ Select Item
			PCI/ISA		Enter: Select
			PCI/ISA		+ - Change Field
			PCI/ISA		F1: General Help
			PCI/ISA		F2: Previous Values
			PCI/ISA		F3: Optimized Default
			PCI/ISA		F4: Save ESC: Exit

**Intel IGD SWSCI OpRegion**

Aptio Setup Utility					
Main	Advanced	Chipset	Boot	Security	Save & Exit
Intel IGD SWSCI OpRegion Configuration					
	DVMT Mode Select		DVMT Mode		
	DVMT/FIXED Memory		256MB		
	IGD - Boot Type		VBIOS Default		
	LCD Panel Type		1024x768 LVDS		
	Panel Scaling		Auto		
					→ ← Select Screen
					↑ ↓ Select Item
					Enter: Select
					+ - Change Field
					F1: General Help
					F2: Previous Values
					F3: Optimized Default
					F4: Save ESC: Exit

**DVMT Mode Select**

Select DVMT Mode used by Internal Graphics Device.

**DVMT/FIXED Memory**

Select DVMT/FIXED Mode Memory size used by Internal Graphics Device. Options are 128MB, 256MB and Maximum.

**IGD - Boot Type**

Select the Video Device that will be activated during POST. This has no effect if external graphics present.

*Note: When using the DVI port only, choose EFP option.*

**LCD Panel Type**

Select LCD Panel used by Internal Graphics Device by selecting the appropriate setup item.

**Panel Scaling**

Select the LCD panel scaling option used by the Internal Graphics Device.

**USB Configuration**

Aptio Setup Utility

Main	<b>Advanced</b>	Chipset	Boot	Security	Save & Exit
USB Configuration					→ ← Select Screen
USB Devices:					↑ ↓ Select Item
2 Hubs					Enter: Select
Legacy USB Support					+ - Change Field
Enabled					F1: General Help
EHCI Hand-off					F2: Previous Values
Disabled					F3: Optimized Default
Port 60/64 Emulation					F4: Save   ESC: Exit
Enabled					
USB hardware delays and time-outs:					
USB Transfer time-out					20 sec
Device reset time-out					20 sec
Device power-up delay					AUTO

**Legacy USB Support**

Enables Legacy USB support.

AUTO option disables legacy support if no USB devices are connected.

DISABLE option will keep USB devices available only for EFI applications.

**EHCI Hand-off**

Enabled/Disabled. This is a workaround for OSes without EHCI hand-off support. The EHCI ownership change should be claimed by EHCI driver.

**Port 64/60 Emulation**

Enables I/O port 60h/64h emulation support. This should be enabled for the complete USB keyboard legacy support for non-USB aware OSes.

**USB Transfer time-out**

The time-out value for Control, Bulk, and Interrupt transfers.

**Device reset time-out**

USB mass Storage device start Unit command time-out.

**Device power-up delay**

Maximum time the device will take before it properly reports itself to the Host Controller. 'Auto' uses default value: for a Root port it is 100ms, for a Hub port the delay is taken from Hub descriptor.

## Super IO Configuration

Aptio Setup Utility					
Main	Advanced	Chipset	Boot	Security	Save & Exit
Super IO Configuration					
Super IO Chip		Winbond W83627DHG			→ ← Select Screen
▶ Serial Port 0 Configuration					↑ ↓ Select Item
▶ Serial Port 1 Configuration					Enter: Select
▶ Parallel Port Configuration					+ - Change Field
Restore AC Power Loss		Always off			F1: General Help
Power On Function		None			F2: Previous Values
LCD Backlight Control		1(Max)			F3: Optimized Default
					F4: Save ESC: Exit

### Serial Port Configuration

Set Parameters of Serial Ports. User can Enable/Disable the serial port and Select an optimal settings for the Super IO Device.

#### Restore AC Power Loss

Always on

Always off (default)

#### Power On function

None (default)

Mouse Left

Mouse Right

Any key

#### LCD Backlight Control

1(Max) (default)

2

3

4

5

6

7

8(Min)

**H/W Monitor**

Aptio Setup Utility

Main	Advanced	Chipset	Boot	Security	Save & Exit
	CPU Smart Fan Control		[Disabled]		
	SYSTIN temperature		+39 C		
	CPUTIN temperature		+38 C		
	SYS FAN Speed		N/A		
	CPU FAN0 Speed		N/A		
	CPU FAN1 Speed		N/A		
	CPUVCORE		+ 1.184V		
	VCC12		+12.355V		→ ← Select Screen
	3VCC		+3.456 V		↑ ↓ Select Item
	DDR 1.5V		+1.520 V		Enter: Select
	VCC5		+5.171 V		+ - Change Field
	3VSB		+3.456 V		F1: General Help
					F2: Previous Values
					F3: Optimized Default
					F4: Save ESC: Exit

**Temperatures/Voltages**

These fields are the parameters of the hardware monitoring function feature of the motherboard. The values are read-only values as monitored by the system and show the PC health status.

**CPU Smart Fan Control**

Disabled (default)

55 C

60 C

65 C

70 C

## Chipset Settings

This section allows you to configure and improve your system and allows you to set up some system features according to your preference.

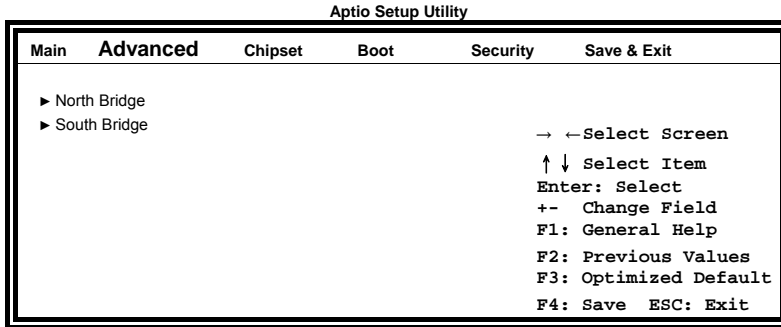

### North Bridge

This item shows the North Bridge Parameters.

### South Bridge

This item shows the South Bridge Parameters.

## North Bridge

This section allows you to configure the North Bridge Chipset.

Aptio Setup Utility					
Main	Advanced	Chipset	Boot	Security	Save & Exit
Memory Information					
Total Memory		4096 MB (DDR3 1066)			→ ← Select Screen
Memory SlotA		2048 MB (DDR3 1066)			↑ ↓ Select Item
Memory SlotB		2048 MB (DDR3 1066)			Enter: Select
Low MMIO Align		1024M			+ - Change Field
DMI Gen2		Enabled			F1: General Help
VT-d		Disabled			F2: Previous Values
Initiate Graphic Adapter		PEG/IGD			F3: Optimized Default
IGD Memory		64M			F4: Save ESC: Exit
Render Standby		Enabled			
IGD Multi-Monitor		Disabled			
PCI Express Port		Auto			
PEG Force Gen1		Disabled			
Detect Non-Compliance		Disabled			

### Low MMIO Align

Low MMIO resources align at 64MB/1024MB.

### VT-d

VT-d Enable/Disable.

### Initiate Graphic Adapter

Select which graphics controller to use as the primary boot device. Options are IGD, PCI/IGD, PCI/PEG, PEG/IGD, PEG/PCI and SG.

### IGD Memory

IGD Share Memory Size. Options are Disable, 32M, 64M and 128M.

### Render Standby

Enabled/Disabled Render standby by Internal Graphics Device.

### IGD Multi-Monitor

Enabled/Disabled IGD Multi-Monitor by Internal Graphics Device.

**PCI Express Port**

Options are Disabled, Enabled and Auto.

**PEG Force Gen1**

PCI Express Port Force Gen1. Options are Disabled and Enabled.

**Detect Non-Compliance**

Detect Non-Compliance PCI Express Device in PEG.

**SB Chipset Configuration**

This section allows you to configure the South Bridge Chipset.

Aptio Setup Utility					
Main	Advanced	Chipset	Boot	Security	Save & Exit
SB Chipset Configuration					
GbE Controller			Enabled		
Wake on LAN from S5			Enabled		
Audio Configuration					
Azalia HD Audio			Enabled		→ ← Select Screen
High Precision Event Timer Configuration					
High Precision Timer			Enabled		↑ ↓ Select Item
PCI Express Ports Configuration					
USB Configuration					
					Enter: Select
					+ - Change Field
					F1: General Help
					F2: Previous Values
					F3: Optimized Default
					F4: Save ESC: Exit

**GbE Controller**

This is constantly enabled.

**Wake on LAN from S5**

Wake on LAN from S5 help.

**Audio Configuration**

The Audio Configuration settings Enable/Disable the Azalia HD Audio and the Azalia internal HDMI codec.

**High Precision Event Timer Configuration**

Enable/or Disable the High Precision Event Timer.

### PCI Express Ports Configuration

Enable or Disable the PCI Express Ports in the Chipset.

Aptio Setup Utility					
Main	Advanced	Chipset	Boot	Security	Save & Exit
PCI Express Ports Configuration					
		PCI Express Port 1	Auto		
		PCI Express Port 2	Auto		
		PCI Express Port 3	Auto		
		PCI Express Port 4	Auto		
		PCI Express Port 5	Auto		
		PCI Express Port 6	Auto		→ ← Select Screen
		PCI Express Port 7	Auto		↑ ↓ Select Item
		PCI Express Port 8	Auto		Enter: Select
					+ - Change Field
		PCIe Sub Decode	Disabled		F1: General Help
					F2: Previous Values
					F3: Optimized Default
					F4: Save ESC: Exit

### USB Configuration

Enable/Disable All USB Devices, USB 2.0 (EHCI) Support and RMH Support. The setting of AUTO on RMH Support Enable RMH support on Ibex Peak B0 Stepping.

Aptio Setup Utility					
Main	Advanced	Chipset	Boot	Security	Save & Exit
USB Configuration					
		All USB Devices	Enabled		
		EHCI Controller 1	Enabled		→ ← Select Screen
		EHCI Controller 2	Enabled		↑ ↓ Select Item
					Enter: Select
					+ - Change Field
		USB Port 0	Enabled		F1: General Help
		USB Port 1	Enabled		F2: Previous Values
		USB Port 2	Enabled		F3: Optimized Default
		USB Port 3	Enabled		F4: Save ESC: Exit
		USB Port 4	Enabled		
		USB Port 5	Enabled		
		USB Port 6	Enabled		
		USB Port 7	Enabled		
		USB Port 8	Enabled		
		USB Port 9	Enabled		
		USB Port 10	Enabled		
		USB Port 11	Enabled		
		USB Port 12	Enabled		
		USB Port 13	Enabled		

**Boot Settings**

Aptio Setup Utility

Main	Advanced	Chipset	Boot	Security	Save & Exit
Boot Configuration					
Setup Prompt Timeout			1		
Bootup NumLock State			On		
Quiet Boot			Disabled		
Fast Boot			Disabled		
CSM16 Module Version			07.64		→ ← Select Screen
GateA20 Active			Upon Request		↑ ↓ Select Item
Option ROM Messages			Force BIOS		Enter: Select
Interrupt 19 Capture			Disabled		+ - Change Field
Boot Option Priorities					F1: General Help
Hard Drive BBS Priorities					F2: Previous Values
					F3: Optimized Default
					F4: Save ESC: Exit

**Setup Prompt Timeout**

Number of seconds to wait for setup activation key. 65535(0xFFFF) means indefinite waiting.

**Bootup NumLock State**

Select the keyboard NumLock state.

**Quiet Boot**

Enables/Disables Quiet Boot option.

**Fast Boot**

Enables/Disables boot with initialization of a minimal set of devices required to launch active boot option. Has no effect for BBS boot options.

**GateA20 Active**

UPON REQUEST – GA20 can be disabled using BIOS services. ALWAYS – do not allow disabling GA20; this option is useful when anyRT code is executed above 1MB.

**Option ROM Messages**

Set display mode for Option ROM. Options are Force BIOS and Keep Current.

**Interrupt 19 Capture**

Enable: Allows Option ROMs to trap Int 19.

**Boot Option Priorities**

Sets the system boot order.

## Security Settings

This section allows you to configure and improve your system and allows you to set up some system features according to your preference.

Aptio Setup Utility					
Main	Advanced	Chipset	Boot	Security	Save & Exit
Password Description  If ONLY the Administrator's password is set, then this only limits access to Setup and is only asked for when entering Setup. If ONLY the User's password is set, then this is a power on password and must be entered to boot or enter Setup. In Setup the User will have Administrator rights  Administrator Password User Password		→ ← Select Screen ↑ ↓ Select Item Enter: Select +- Change Field F1: General Help F2: Previous Values F3: Optimized Default F4: Save ESC: Exit			

### Administrator Password

Set Setup Administrator Password.

### User Password

Set User Password.

## Save & Exit Settings

Aptio Setup Utility					
Main	Advanced	Chipset	Boot	Security	Save & Exit
Save Changes and Exit				→ ← Select Screen ↑ ↓ Select Item Enter: Select +- Change Field F1: General Help F2: Previous Values F3: Optimized Default F4: Save ESC: Exit	
Discard Changes and Exit					
Save Changes and Reset					
Discard Changes and Reset					
Save Options					
Save Changes					
Discard Changes					
Restore Defaults					
Save as User Defaults					
Restore User Defaults					
Boot Override					
Launch EFI Shell from filesystem device					

### Save Changes and Exit

Exit system setup after saving the changes.

### Discard Changes and Exit

Exit system setup without saving any changes.

### Save Changes and Reset

Reset the system after saving the changes.

### Discard Changes and Reset

Reset system setup without saving any changes.

### Save Changes

Save Changes done so far to any of the setup options.

### Discard Changes

Discard Changes done so far to any of the setup options.

### Restore Defaults

Restore/Load Defaults values for all the setup options.

**Save as User Defaults**

Save the changes done so far as User Defaults.

**Restore User Defaults**

Restore the User Defaults to all the setup options.

**Boot Override**

Pressing ENTER causes the system to enter the OS.

**Launch EFI Shell from filesystem device**

Attempts to Launch EFI Shell application (Shellx64.efi) from one of the available filesystem devices.

**This page is intentionally left blank.**

## Drivers Installation

This chapter describes the installation procedures for software and drivers. The software and drivers are included with the motherboard. If you find the items missing, please contact the vendor where you made the purchase. The contents of this section include the following:

Intel Chipset Software Installation Utility .....	64
VGA Drivers Installation .....	65
Realtek HD Audio Driver Installation .....	66
LAN Drivers Installation .....	67-68
Intel® Management Engine Interface .....	69-70

**IMPORTANT NOTE:**

After installing your Windows operating system, you must install first the Intel Chipset Software Installation Utility before proceeding with the drivers installation.

## Intel Chipset Software Installation Utility

The Intel Chipset Drivers should be installed first before the software drivers to enable Plug & Play INF support for Intel chipset components. Follow the instructions below to complete the installation.

1. Insert the CD that comes with the board. Click **Intel** and then **Intel(R) QM67/Q67 Chipset Drivers**.



2. Click **Intel(R) Chipset Software Installation Utility**.



3. When the Welcome screen to the Intel® Chipset Device Software appears, click **Next** to continue.

4. Click **Yes** to accept the software license agreement and proceed with the installation process.

5. On the Readme File Information screen, click **Next** to continue the installation.

6. The Set up process is now complete. Click **Finish** to restart the computer and for changes to take effect.

## VGA Drivers Installation

**NOTE:** Before installing the *Intel(R) Q67 Chipset Family Graphics Driver*, the Microsoft .NET Framework 3.5 SPI should be first installed.

1. Insert the CD that comes with the board. Click *Intel* and then *Intel(R) QM67/Q67 Chipset Drivers*.

2. Click *Intel(R) Q67 Chipset Family Graphics Driver*.



3. When the Welcome screen appears, click *Next* to continue.



4. Click *Yes* to agree with the license agreement and continue the installation.

5. On the Readme File Information screen, click *Next* to continue the installation of the Intel® Graphics Media Accelerator Driver.

6. On Setup Progress screen, click *Next* to continue.

7. Setup complete. Click *Finish* to restart the computer and for changes to take effect.

## Realtek HD Audio Driver Installation

Follow the steps below to install the Realtek HD Audio Drivers.

1. Insert the CD that comes with the board. Click *Intel* and then *Intel(R) QM67/Q67 Chipset Drivers*.

2. Click *Realtek High Definition Audio Driver*.



3. On the Welcome to the InstallShield Wizard screen, click *Yes* to proceed with and complete the installation process.



## LAN Drivers Installation

1. Insert the CD that comes with the board. Click **Intel** and then **Intel(R) QM67/Q67 Chipset Drivers**.

2. Click **Intel(R) PRO LAN Network Driver**.



3. When the Welcome screen appears, click **Next**. On the next screen, click **Yes** to agree with the license agreement.

4. Click the checkbox for **Drivers** in the Setup Options screen to select it and click **Next** to continue.

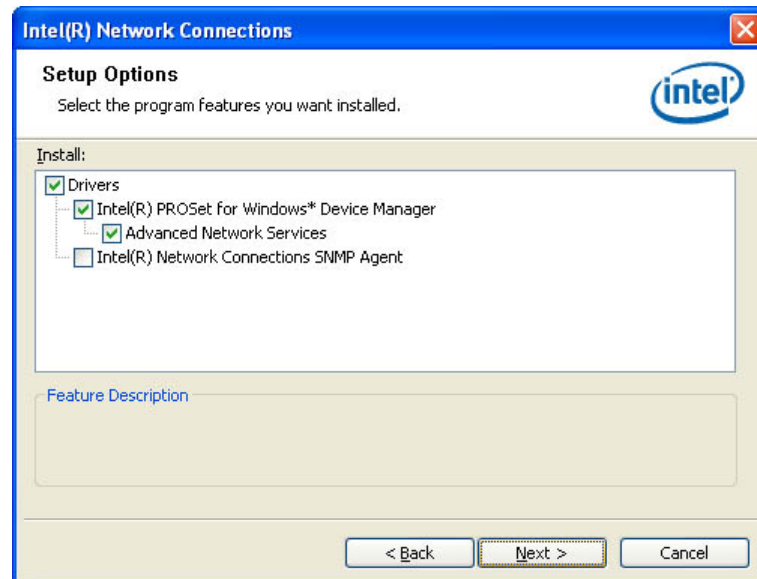

5. The wizard is ready to begin installation. Click **Install** to begin the installation.

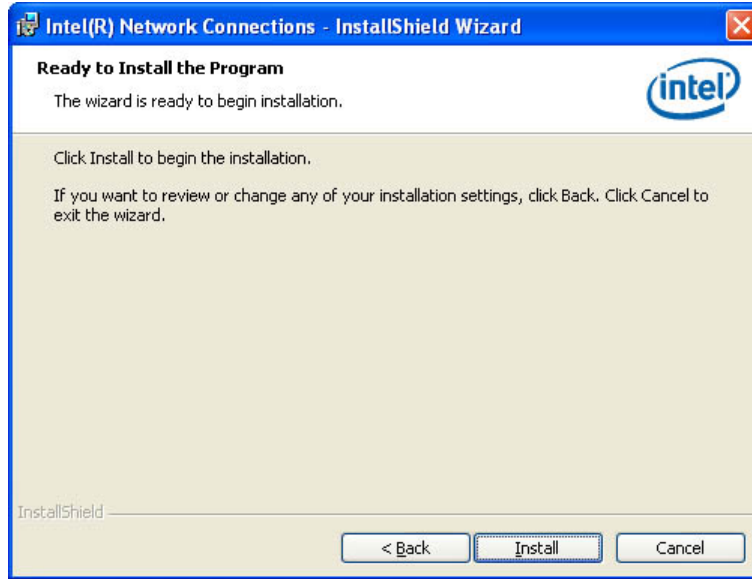

6. When InstallShield Wizard is complete, click **Finish**.

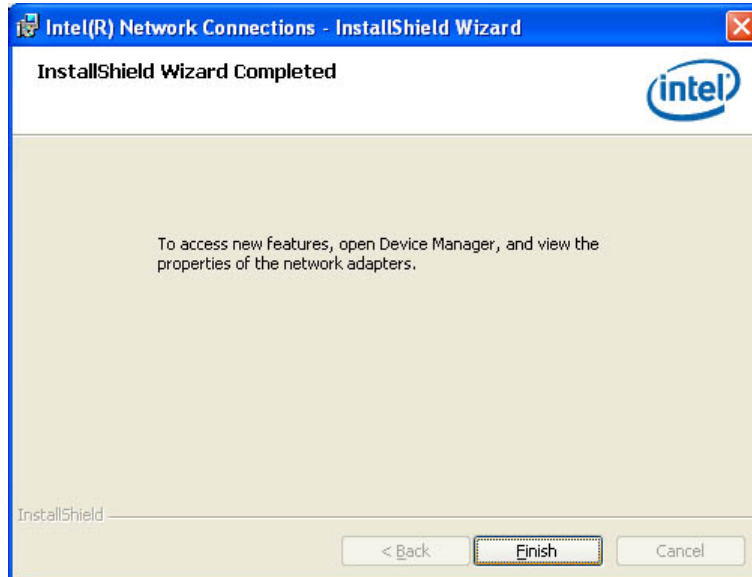

## Intel® Management Engine Interface

**REMARKS: The Intel iAMT 7.0 Drivers need install, but Management Engine Function not support.**



The following application requires Microsoft .NET Framework 3.5 or later: Intel® Management Engine Components. Please install the latest version of Microsoft .NET Framework from Microsoft Download Center to run this application correctly.

Follow the steps below to install the Intel Management Engine.

1. Insert the CD that comes with the board. Click *Intel* and then *Intel(R) AMT 7.0 Drivers*.



2. When the Welcome screen to the InstallShield Wizard for Intel® Management Engine Components, click *Next*. On the next screen, click *Yes* to to agree with the license agreement.

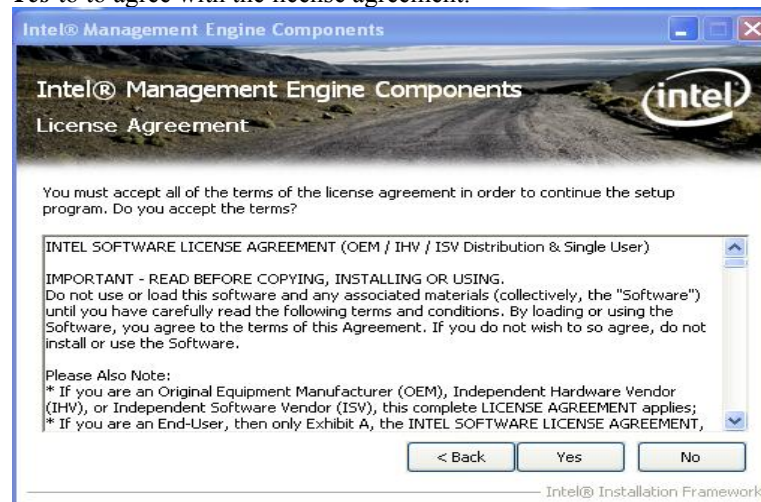

2. When the Setup Progress screen appears, click **Next**. Then, click **Finish** when the setup progress has been successfully installed.

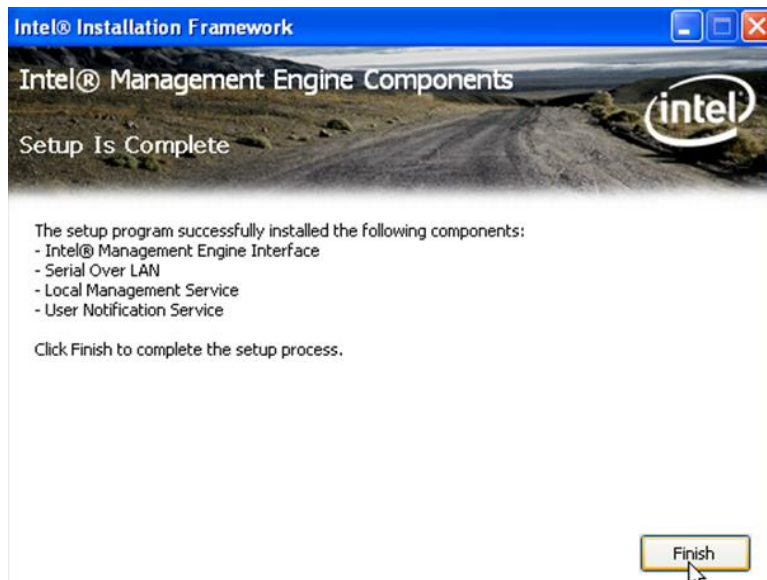
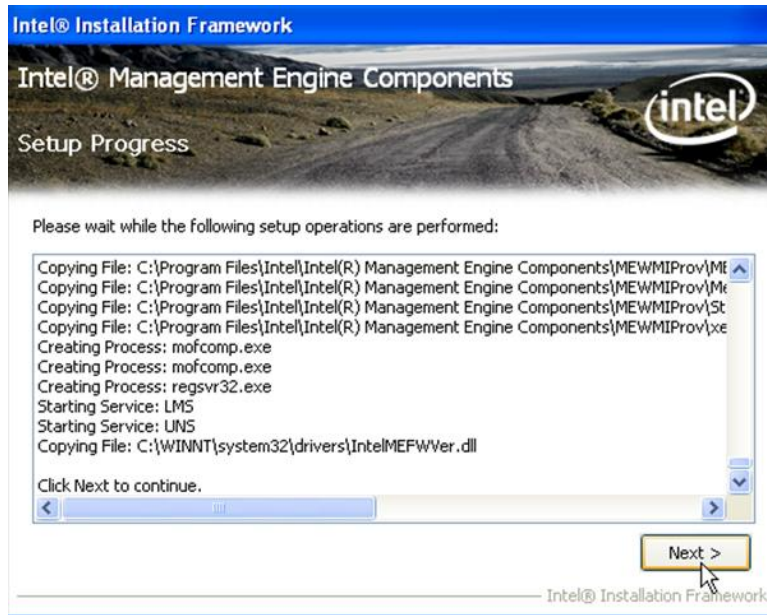

## Appendix

### A. I/O Port Address Map

Each peripheral device in the system is assigned a set of I/O port addresses which also becomes the identity of the device. The following table lists the I/O port addresses used.

Address	Device Description
000h - 01Fh	DMA Controller #1
020h - 03Fh	Interrupt Controller #1
040h - 05Fh	Timer
060h - 06Fh	Keyboard Controller
070h - 07Fh	Real Time Clock, NMI
080h - 09Fh	DMA Page Register
0A0h - 0BFh	Interrupt Controller #2
0C0h - 0DFh	DMA Controller #2
0F0h	Clear Math Coprocessor Busy Signal
0F1h	Reset Math Coprocessor
1F0h - 1F7h	IDE Interface
2F8h - 2FFh	Serial Port #2(COM2)
2B0h- 2DFh	Graphics adapter Controller
360h - 36Fh	Network Ports
3F8h - 3FFh	Serial Port #1(COM1)

## B. Interrupt Request Lines (IRQ)

Peripheral devices use interrupt request lines to notify CPU for the service required. The following table shows the IRQ used by the devices on board.

Level	Function
IRQ0	System Timer Output
IRQ1 Key	board
IRQ3	Serial Port #2
IRQ4	Serial Port #1
IRQ8	Real Time Clock
IRQ14 Prim	ary IDE
IRQ15 Second	ary IDE

## C. Watchdog Timer Configuration

The WDT is used to generate a variety of output signals after a user programmable count. The WDT is suitable for use in the prevention of system lock-up, such as when software becomes trapped in a deadlock. Under these sorts of circumstances, the timer will count to zero and the selected outputs will be driven. Under normal circumstance, the user will restart the WDT at regular intervals before the timer counts to zero.

SAMPLE CODE:

```
//-----
//
// THIS CODE AND INFORMATION IS PROVIDED "AS IS" WITHOUT WARRANTY OF ANY
// KIND, EITHER EXPRESSED OR IMPLIED, INCLUDING BUT NOT LIMITED TO THE
// IMPLIED WARRANTIES OF MERCHANTABILITY AND/OR FITNESS FOR A PARTICULAR
// PURPOSE.
//
//-----
#include <dos.h>
#include <conio.h>
#include <stdio.h>
#include <stdlib.h>
#include "W627DHG.H"
//-----
int main (void);

void WDTInitial(void);
void WDTEnable(unsigned char);
void WDTDisable(void);

//-----
int main (void)
{
    char SIO;

    SIO = Init_W627DHG();
    if (SIO == 0)
    {
        printf("Can not detect Winbond 83627DHG, program
abort.\n");
        return(1);
    }

    WDTInitial();

    WDTEnable(10);

    WDTDisable();

    return 0;
}
//-----
void WDTInitial(void)
{
    unsigned char bBuf;

    bBuf = Get_W627DHG_Reg(0x2D);
    bBuf &= (~0x01);
    Set_W627DHG_Reg(0x2D, bBuf);           //Enable WDTO
}
```

```

//-----
void WDTEnable(unsigned char NewInterval)
{
    unsigned char bBuf;

    Set_W627DHG_LD(0x08);
    Set_W627DHG_Reg(0x30, 0x01);           //enable timer

    bBuf = Get_W627DHG_Reg(0xF5);
    bBuf &= (~0x08);
    Set_W627DHG_Reg(0xF5, bBuf);         //count mode is second

    Set_W627DHG_Reg(0xF6, NewInterval);
    //set timer
}
//-----
void WDTDisable(void)
{
    Set_W627DHG_LD(0x08);
    Set_W627DHG_Reg(0xF6, 0x00);         //clear
watchdog timer
    Set_W627DHG_Reg(0x30, 0x00);         //watchdog
disabled
}
//-----

//-----
//
// THIS CODE AND INFORMATION IS PROVIDED "AS IS" WITHOUT WARRANTY OF ANY
// KIND, EITHER EXPRESSED OR IMPLIED, INCLUDING BUT NOT LIMITED TO THE
// IMPLIED WARRANTIES OF MERCHANTABILITY AND/OR FITNESS FOR A PARTICULAR
// PURPOSE.
//
//-----
#ifndef __W627DHG_H
#define __W627DHG_H                1
//-----
#define W627DHG_INDEX_PORT        (W627DHG_BASE)
#define W627DHG_DATA_PORT        (W627DHG_BASE+1)
//-----
#define W627DHG_REG_LD            0x07
//-----
#define W627DHG_UNLOCK            0x87
#define W627DHG_LOCK              0xAA
//-----
unsigned int Init_W627DHG(void);
void Set_W627DHG_LD(unsigned char);
void Set_W627DHG_Reg(unsigned char, unsigned char);
unsigned char Get_W627DHG_Reg(unsigned char);
//-----
#endif // __W627DHG_H

//-----
//
// THIS CODE AND INFORMATION IS PROVIDED "AS IS" WITHOUT WARRANTY OF ANY
// KIND, EITHER EXPRESSED OR IMPLIED, INCLUDING BUT NOT LIMITED TO THE
// IMPLIED WARRANTIES OF MERCHANTABILITY AND/OR FITNESS FOR A PARTICULAR
// PURPOSE.
//
//-----
#include "W627DHG.H"
#include <dos.h>
//-----
unsigned int W627DHG_BASE;
void Unlock_W627DHG(void);
void Lock_W627DHG(void);
//-----
unsigned int Init_W627DHG(void)
{
    unsigned int result;
    unsigned char ucDid;

    W627DHG_BASE = 0x4E;
    result = W627DHG_BASE;

    ucDid = Get_W627DHG_Reg(0x20);
}

```

```

        if (ucDid == 0xA0)
        {
            goto Init_Finish;
        }
        else if (ucDid == 0xB0)
        {
            goto Init_Finish;
        }
        //W83627DHG-P??

        W627DHG_BASE = 0x2E;
        result = W627DHG_BASE;

        ucDid = Get_W627DHG_Reg(0x20);
        if (ucDid == 0xA0)
        {
            goto Init_Finish;
        }
        else if (ucDid == 0xB0)
        {
            goto Init_Finish;
        }
        //W83627DHG-P??

        W627DHG_BASE = 0x00;
        result = W627DHG_BASE;

Init_Finish:
        return (result);
    }
    //-----
void Unlock_W627DHG (void)
{
    outportb(W627DHG_INDEX_PORT, W627DHG_UNLOCK);
    outportb(W627DHG_INDEX_PORT, W627DHG_UNLOCK);
}
//-----
void Lock_W627DHG (void)
{
    outportb(W627DHG_INDEX_PORT, W627DHG_LOCK);
}
//-----
void Set_W627DHG_LD( unsigned char LD)
{
    Unlock_W627DHG();
    outportb(W627DHG_INDEX_PORT, W627DHG_REG_LD);
    outportb(W627DHG_DATA_PORT, LD);
    Lock_W627DHG();
}
//-----
void Set_W627DHG_Reg( unsigned char REG, unsigned char DATA)
{
    Unlock_W627DHG();
    outportb(W627DHG_INDEX_PORT, REG);
    outportb(W627DHG_DATA_PORT, DATA);
    Lock_W627DHG();
}
//-----
unsigned char Get_W627DHG_Reg(unsigned char REG)
{
    unsigned char Result;
    Unlock_W627DHG();
    outportb(W627DHG_INDEX_PORT, REG);
    Result = inportb(W627DHG_DATA_PORT);
    Lock_W627DHG();
    return Result;
}
//-----

```

## D. TR-7190 Mechanical Drawings

This page is left blank.

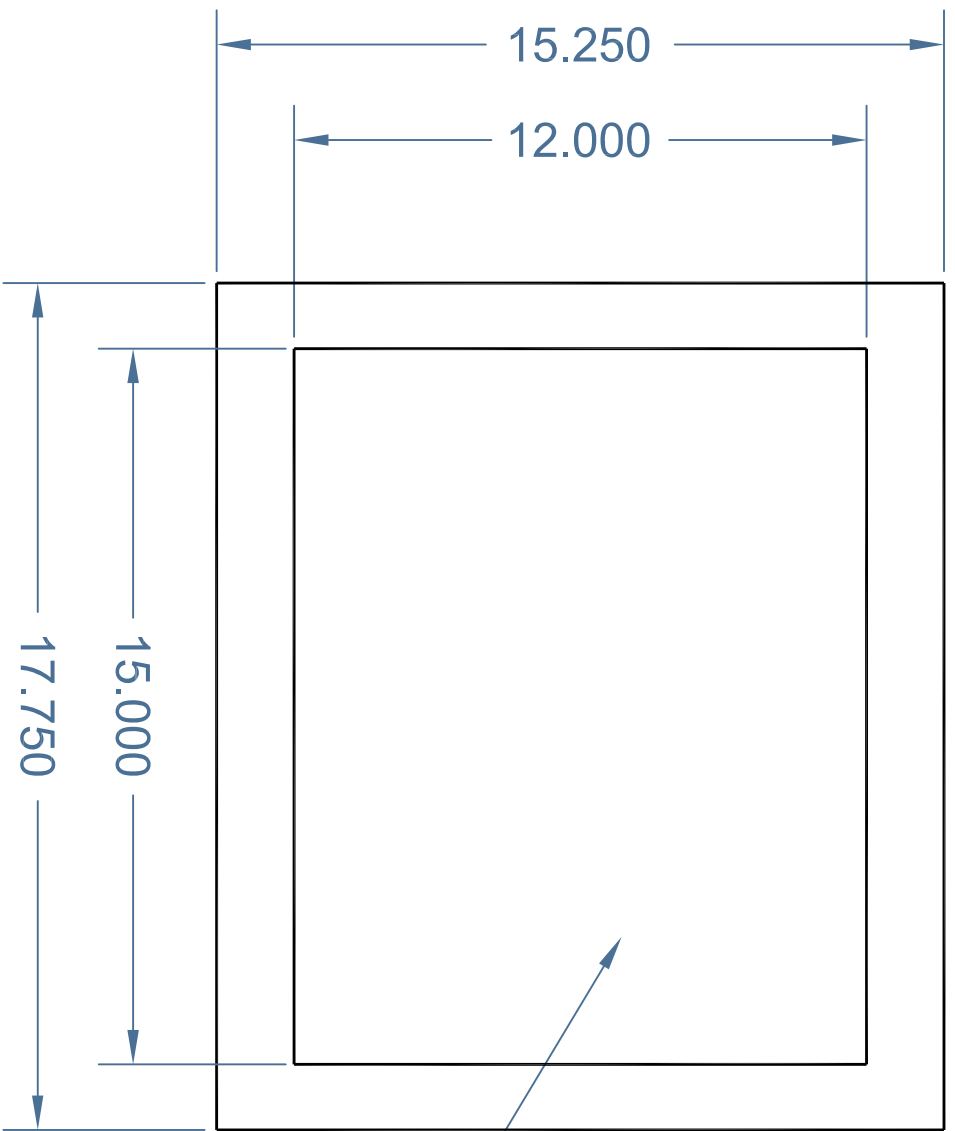

19" LCD MONITOR

FRONT VIEW

DATE	06-25-2012	DRAWN BY	B.G.	MODEL	TR-7190-PM
PRODUCT	PANEL PC		REVISION		
FINISH	CRINKLE BLACK	Transduction		CHECKED BY	NTS
	POWDER PAINT	DRAWING No		B-523	
TITLE	LAYOUT				

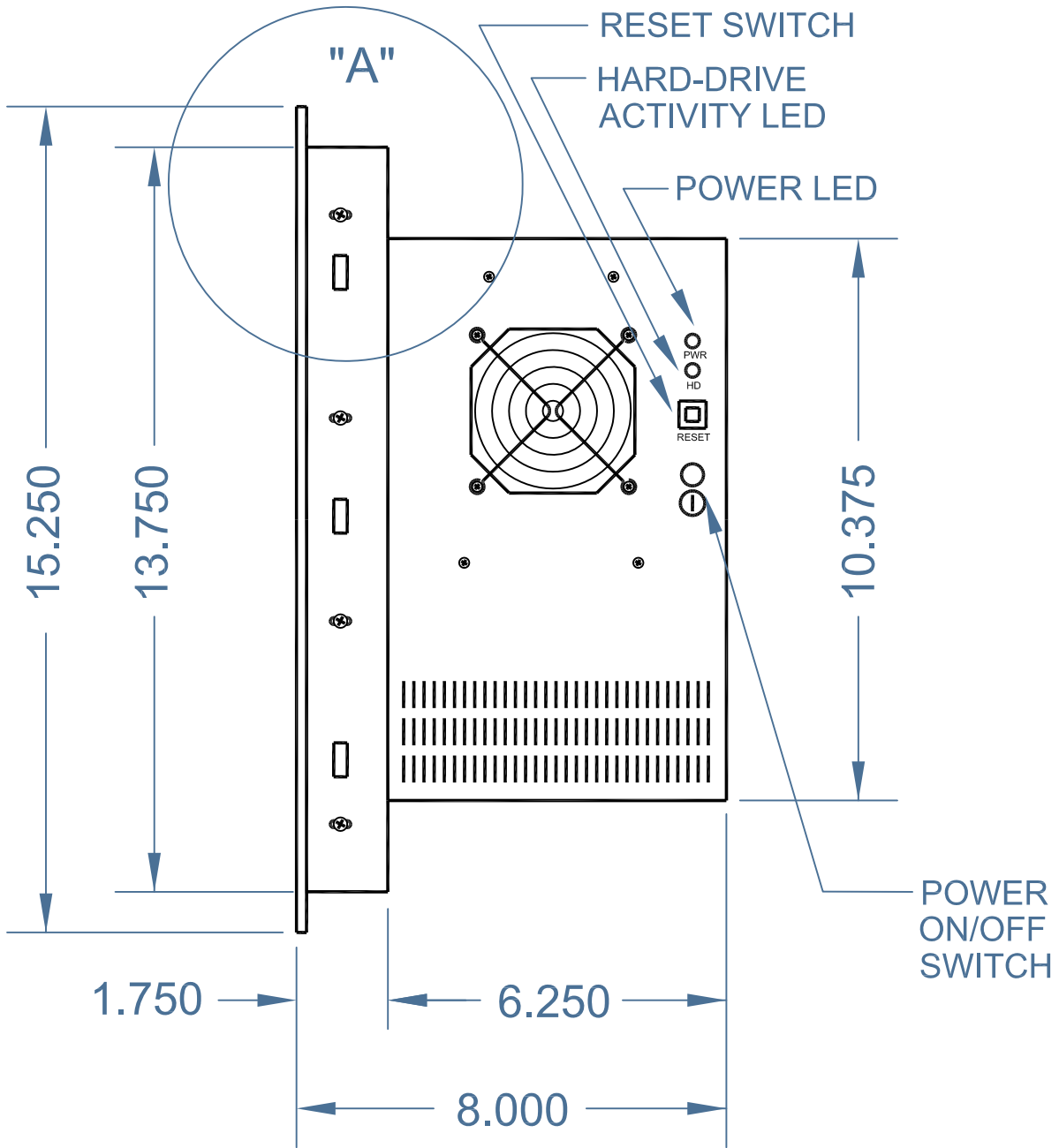

RIGHT SIDE VIEW

NOTE: FOR DETAIL "A" LOOK  
DRAWING B-528

DATE 06-25-2012	DRAWN BY B.G.	MODEL TR-7190-PM		
PRODUCT PANEL PC		REVISION	SCALE	
FINISH CRINKLE BLACK POWDER PAINT	Transduction		CHECKED BY	NTS
TITLE LAYOUT			DRAWING No B-524	

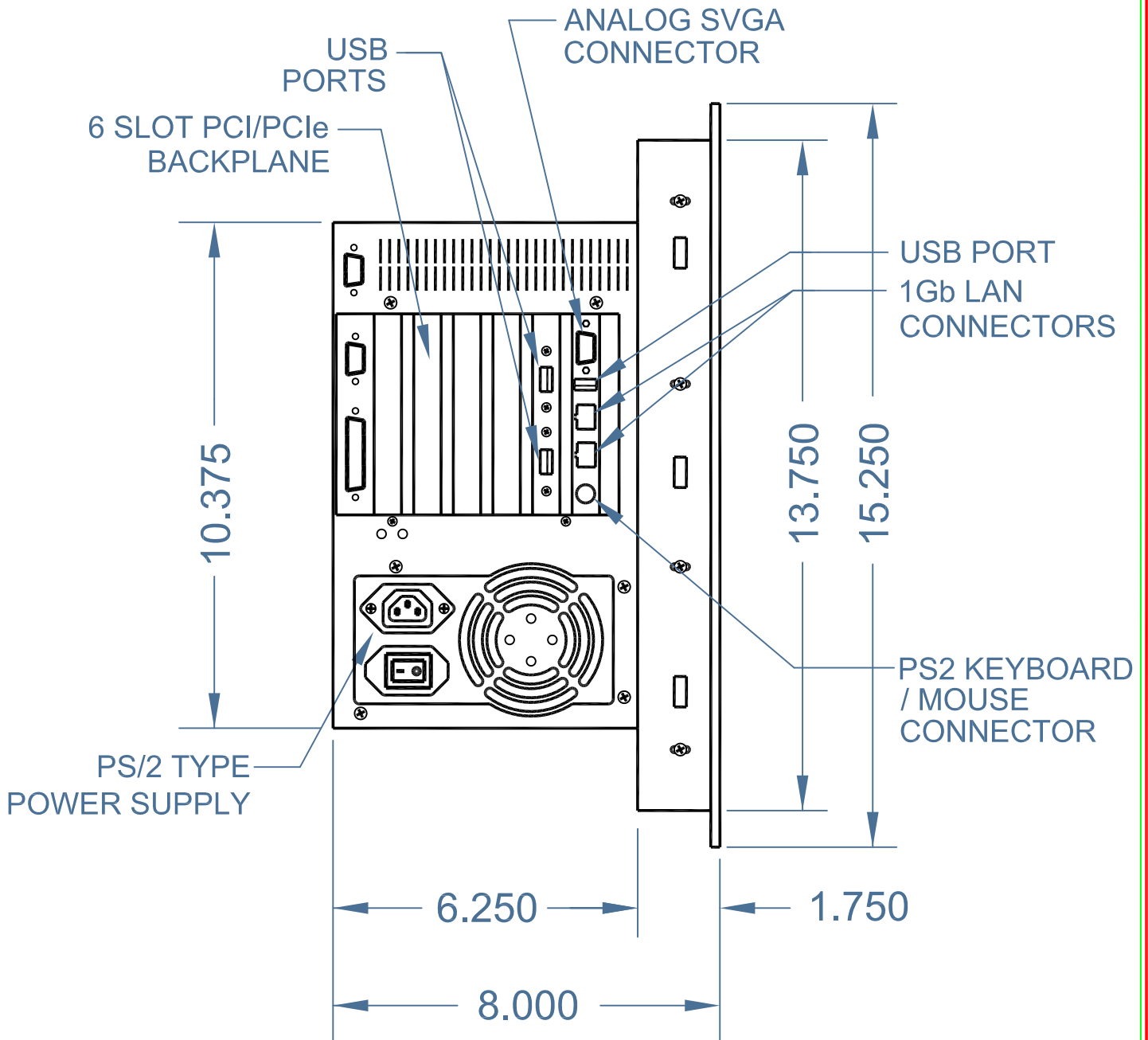

LEFT SIDE VIEW

DATE 06-25-2012	DRAWN BY B.G.	MODEL TR-7190-PM		
PRODUCT PANEL PC		REVISION	SCALE	
FINISH CRINKLE BLACK POWDER PAINT	Transduction		CHECKED BY	NTS
TITLE LAYOUT			DRAWING No B-525	

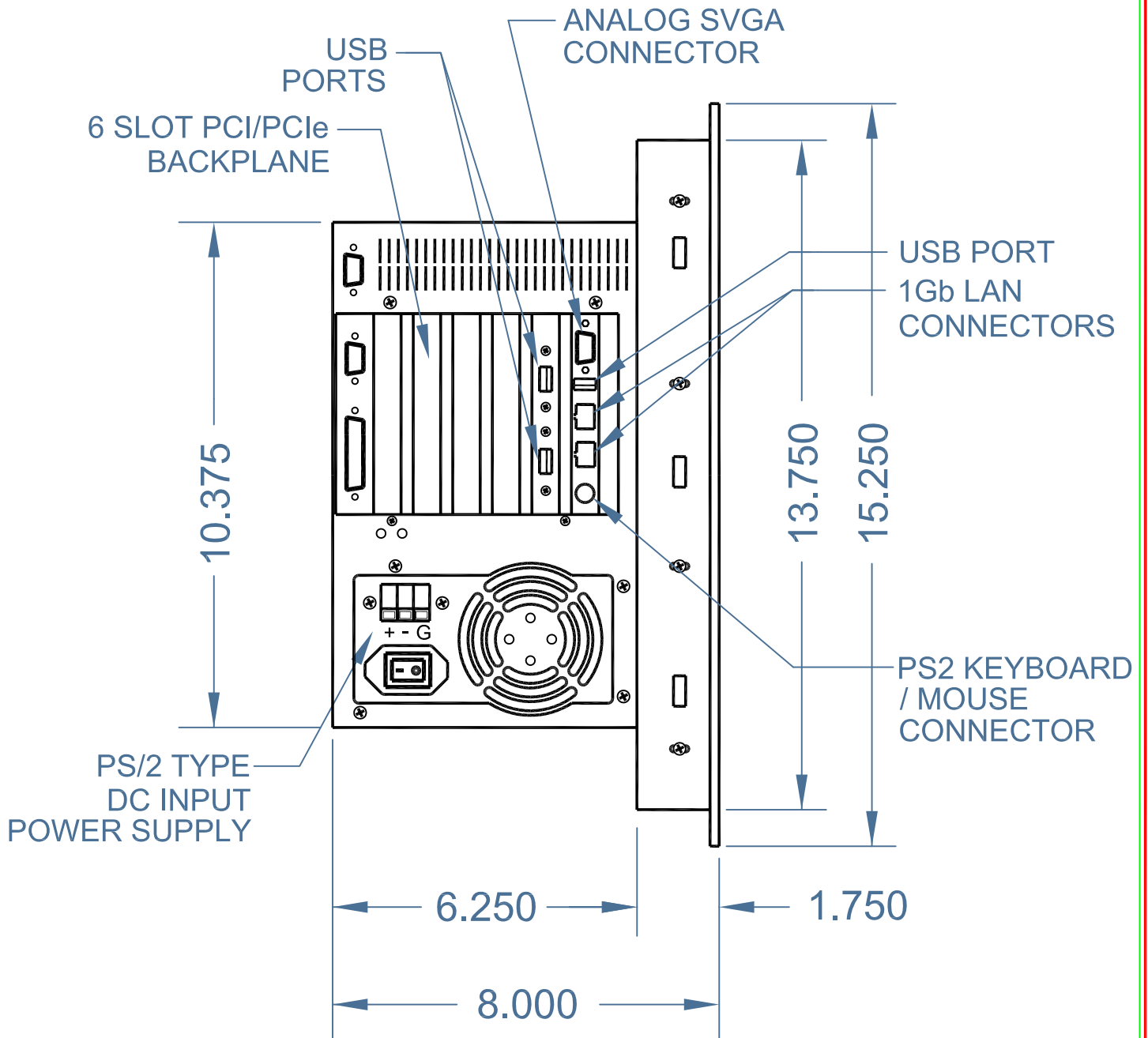

LEFT SIDE VIEW

DATE 06-25-2012	DRAWN BY B.G.	MODEL TR-7190-PM
PRODUCT PANEL PC		REVISION SCALE
FINISH CRINKLE BLACK POWDER PAINT	Transduction	CHECKED BY NTS
TITLE LAYOUT		DRAWING No B-525A

SLIM DVD/CD RW DRIVE

15.250

17.750

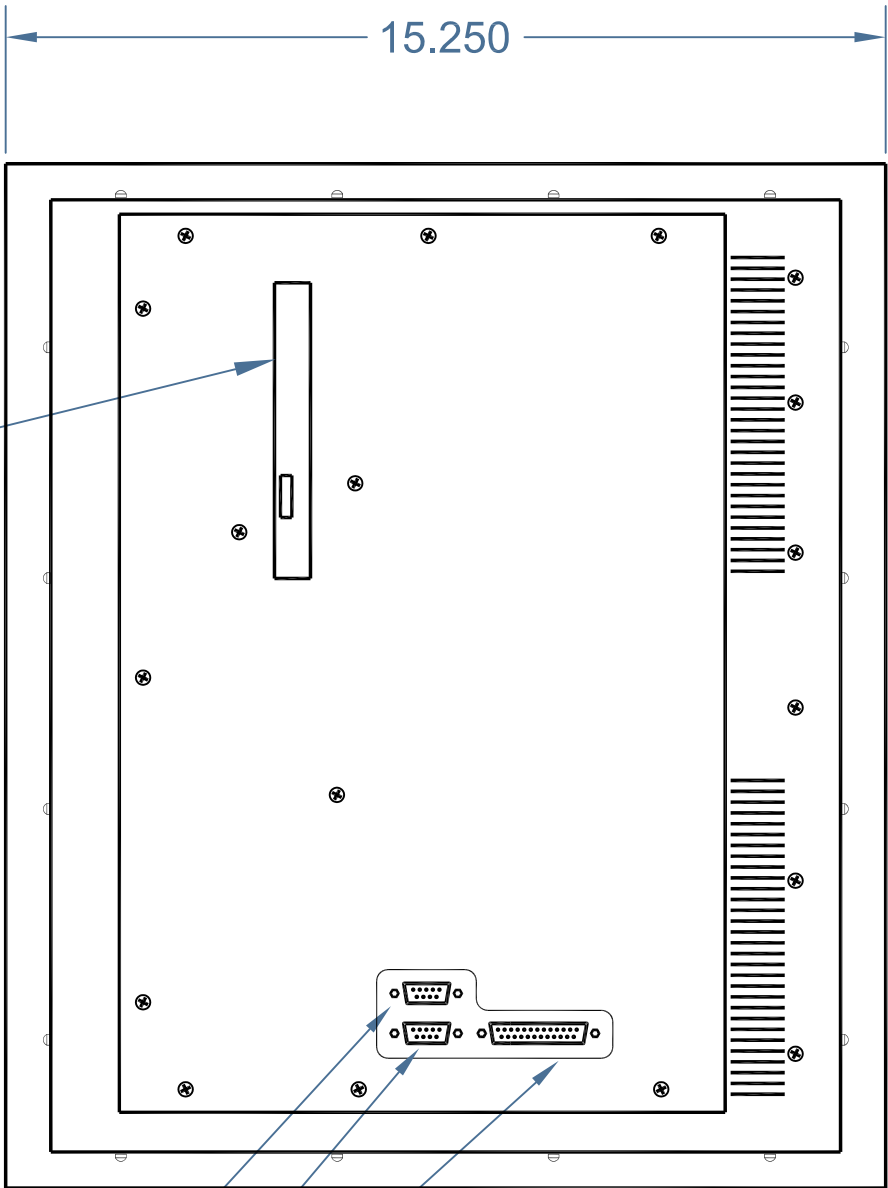

LPT  
COM1  
COM2

REAR VIEW

DATE	06-25-2012	DRAWN BY	B.G.	MODEL	TR-7190-PM
PRODUCT		REVISION		CHECKED BY	NTS
FINISH		Transduction		SCALE	
TITLE	LAYOUT	DRAWING No.	B-526		

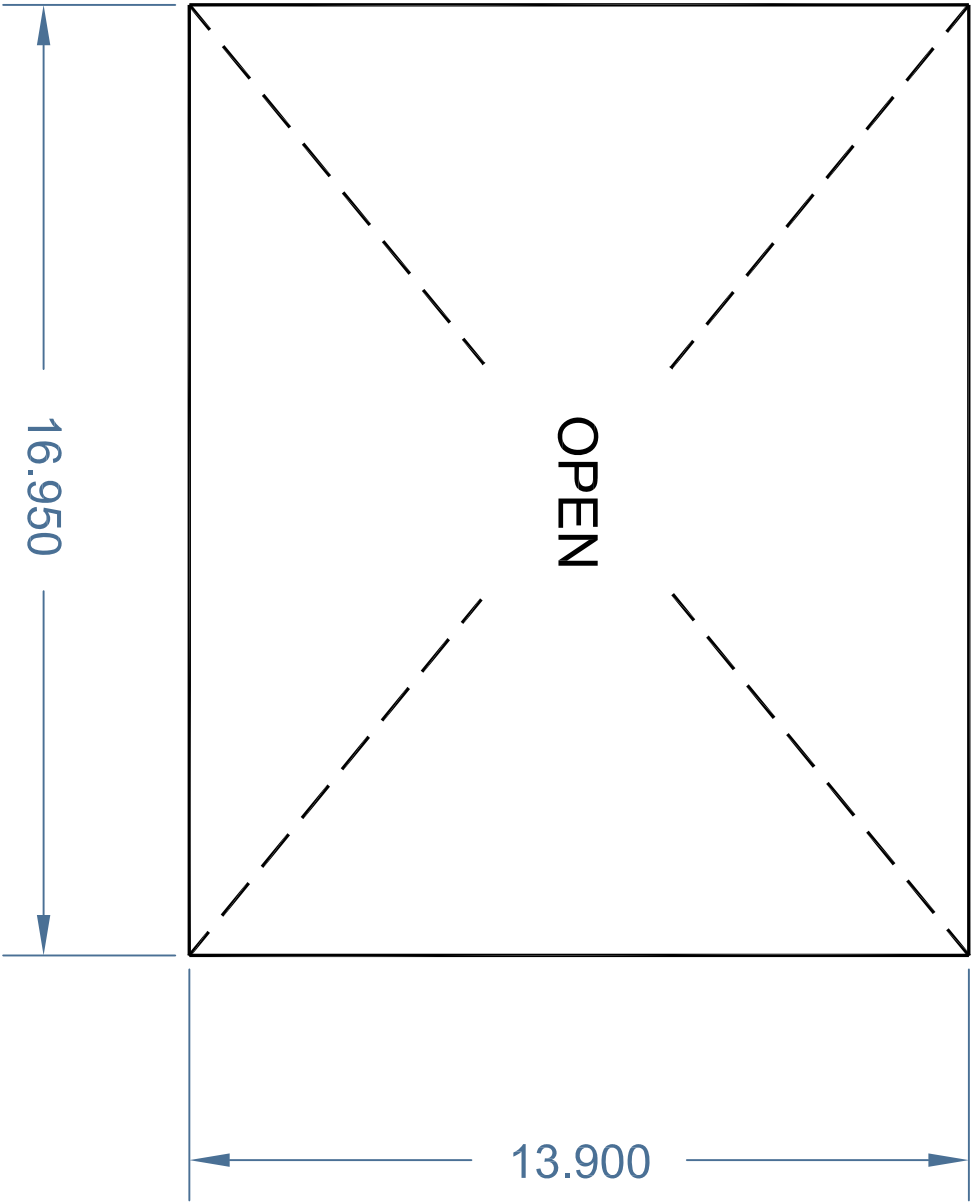

DATE	06-25-2012	DRAWN BY	B.G.	MODEL	TR-7190-PM
PRODUCT	PANEL PC	REVISION		SCALE	
FINISH	Transduction	CHECKED BY	NTS		
TITLE	CUTOUT	DRAWING No	B-527		

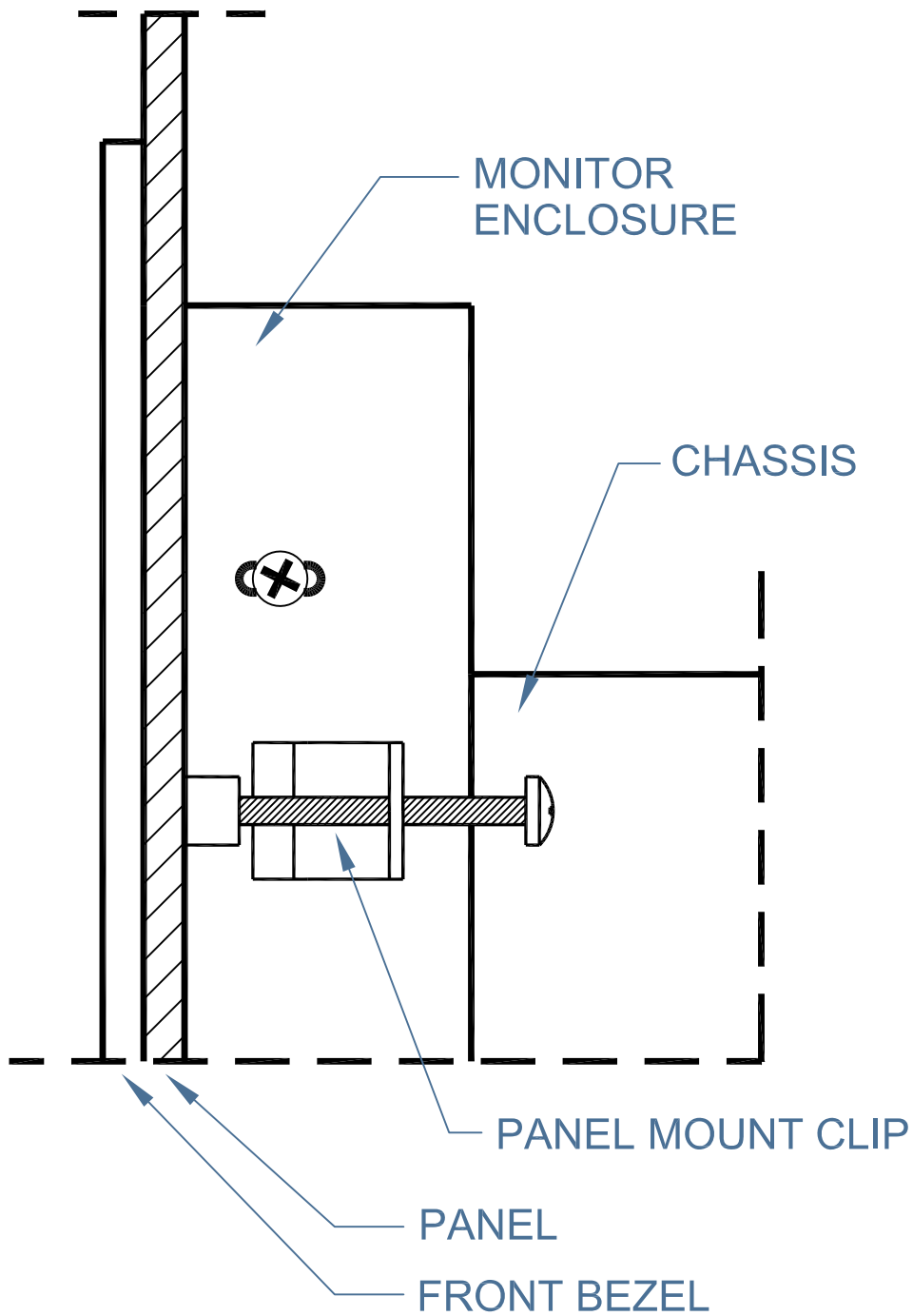

NOTE: CLIP ATTACHED FROM BEHIND AFTER CHASSIS PLACEMENT IN THE PANEL OPENING.

DATE	06-25-2012	DRAWN BY	B. G.	MODEL	TR-7190-PM
PRODUCT	PANEL PC			REVISION	SCALE
FINISH	Transduction			CHECKED BY	NTS
TITLE	DETAIL "A"			DRAWING No	B-528

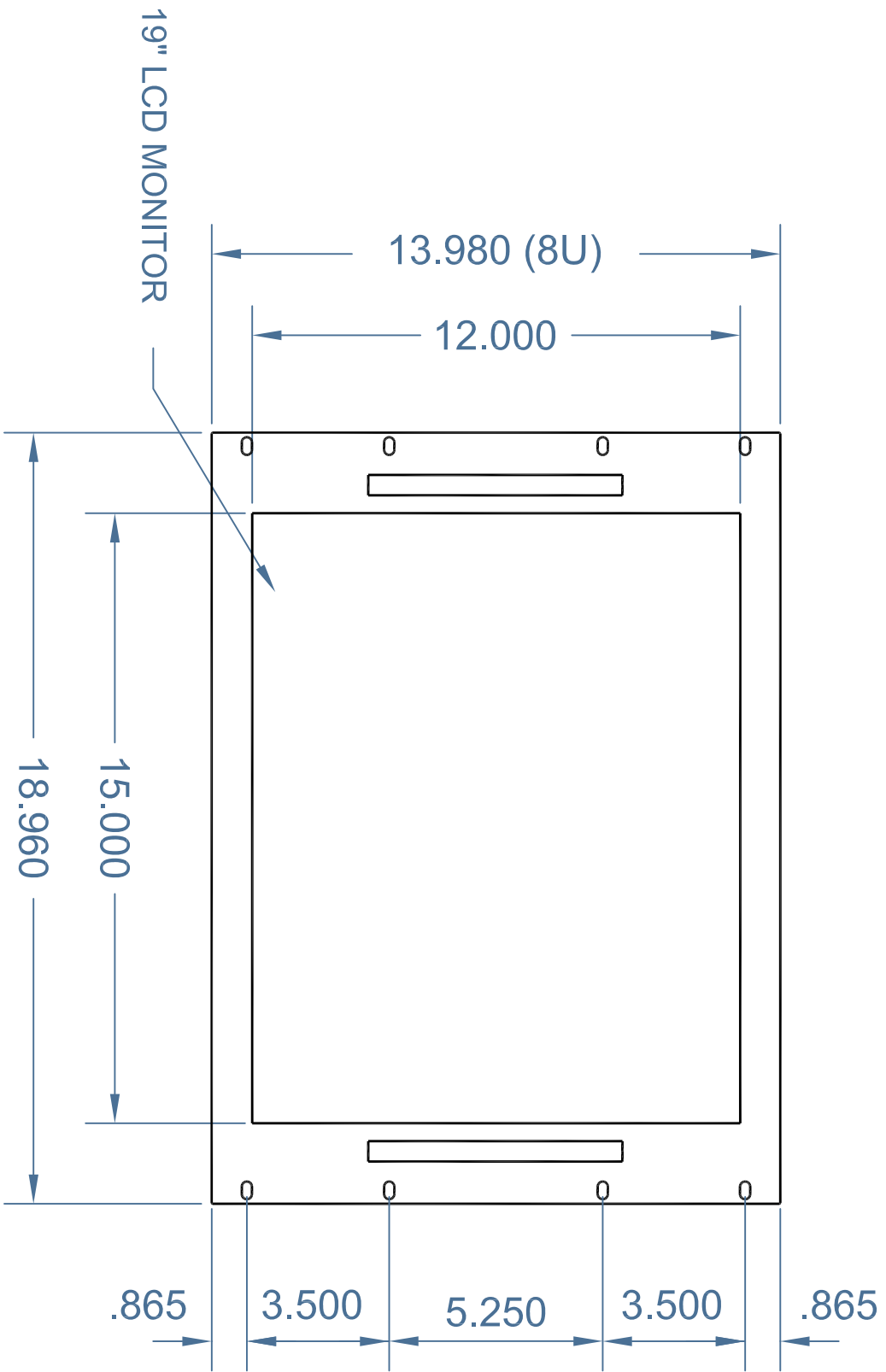

**FRONT VIEW**

DATE	06-25-2012	DRAWN BY	B.G.	MODEL	TR-7190-RM
PRODUCT	PANEL PC-RACK MOUNT VERSION				REVISION
FINISH	CRINKLE BLACK	Transduction		CHECKED BY	NTS
TITLE	LAYOUT			DRAWING No.	B-529
				SCALE	

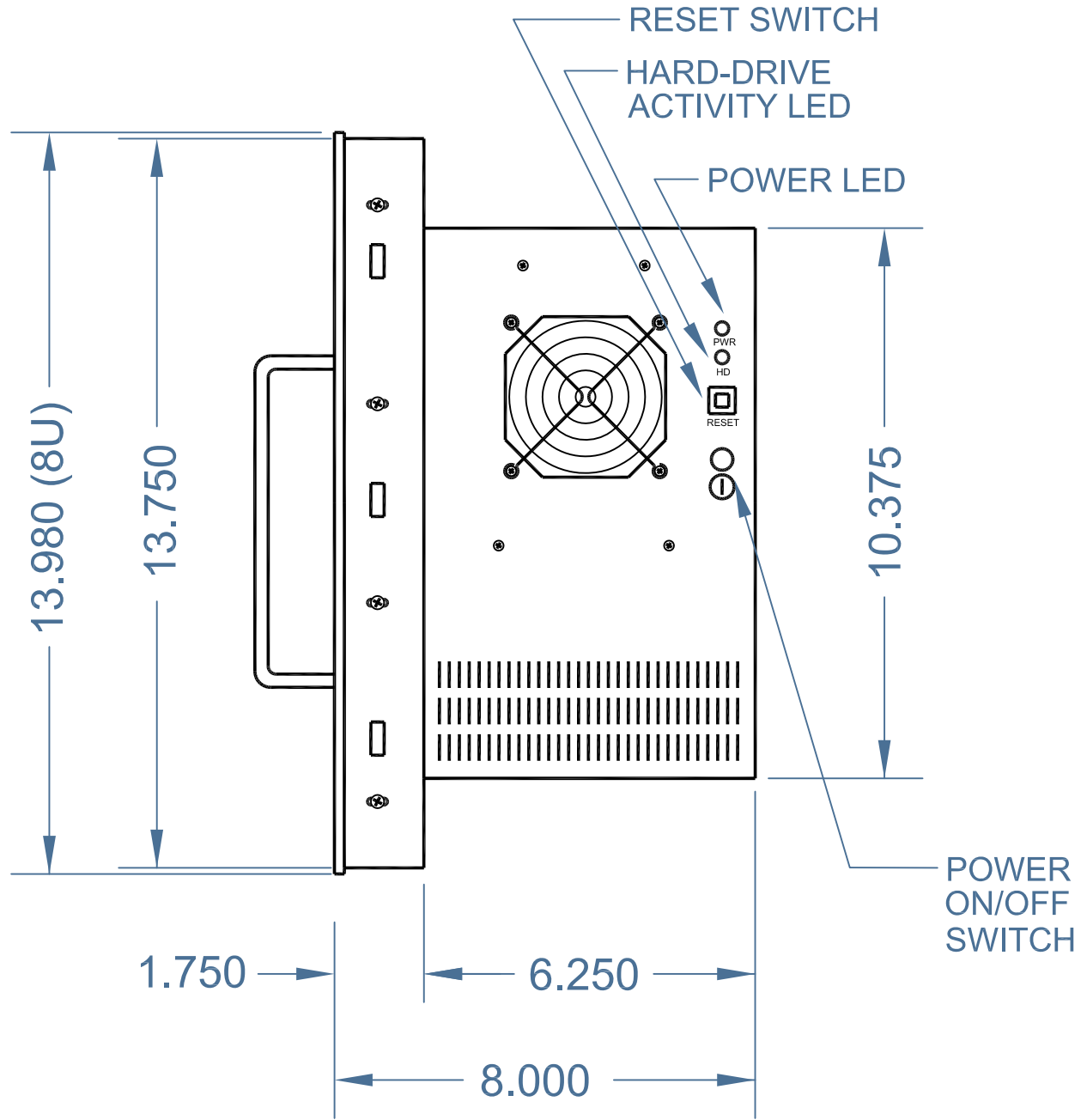

**RIGHT SIDE VIEW**

DATE 06-25-2012	DRAWN BY B. G.	MODEL TR-7190-RM
PRODUCT PANEL PC-RACK MOUNT VERSION		REVISION
FINISH CRINKLE BLACK POWDER PAINT	Transduction	CHECKED BY NTS
TITLE LAYOUT		DRAWING No B-530

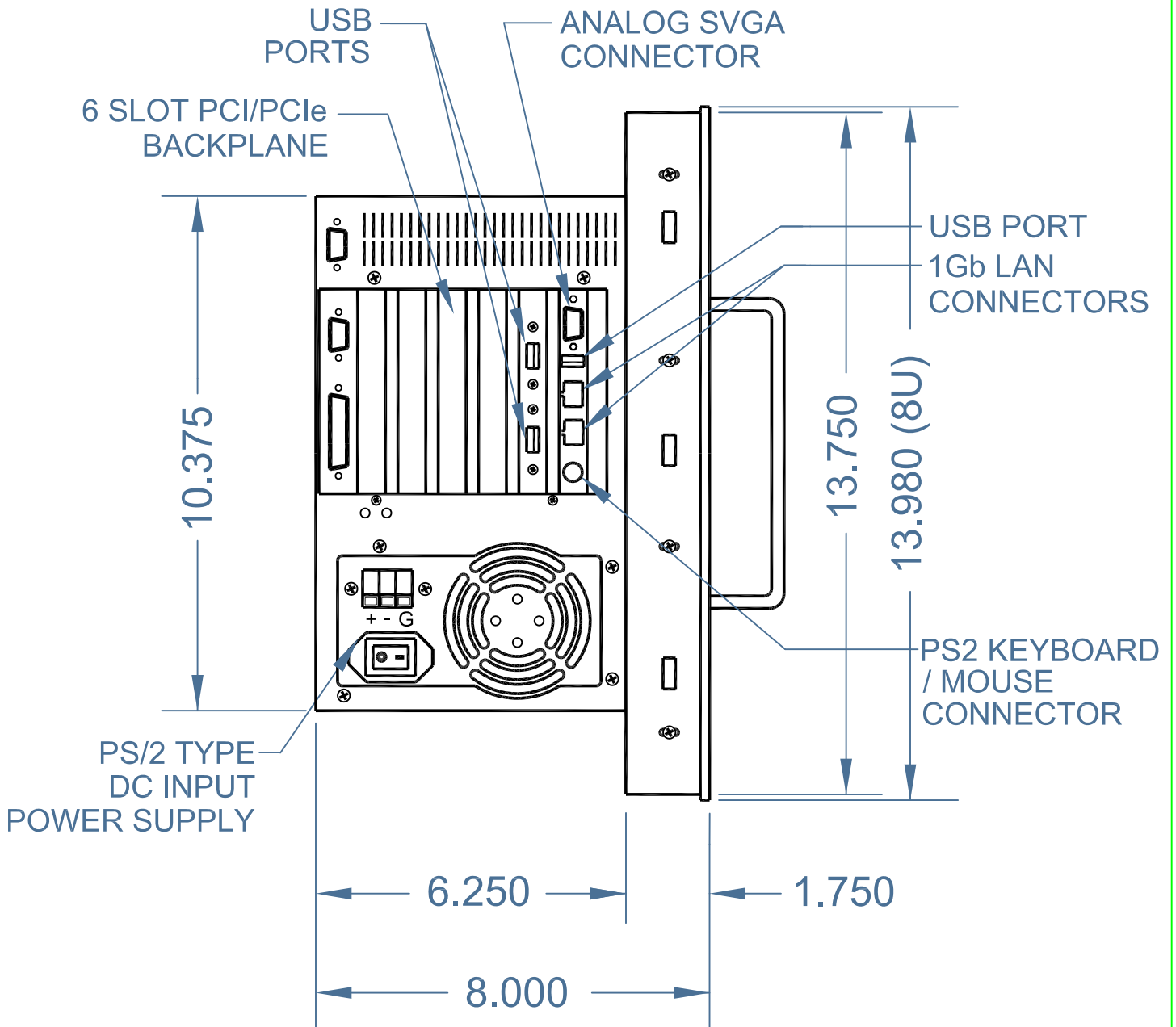

LEFT SIDE VIEW

DATE 06-25-2012	DRAWN BY B. G.	MODEL TR-7190-RM		
PRODUCT DC INPUT OPTION		REVISION	SCALE	
FINISH Transduction		CHECKED BY	NTS	
TITLE LAYOUT		DRAWING No B-531		

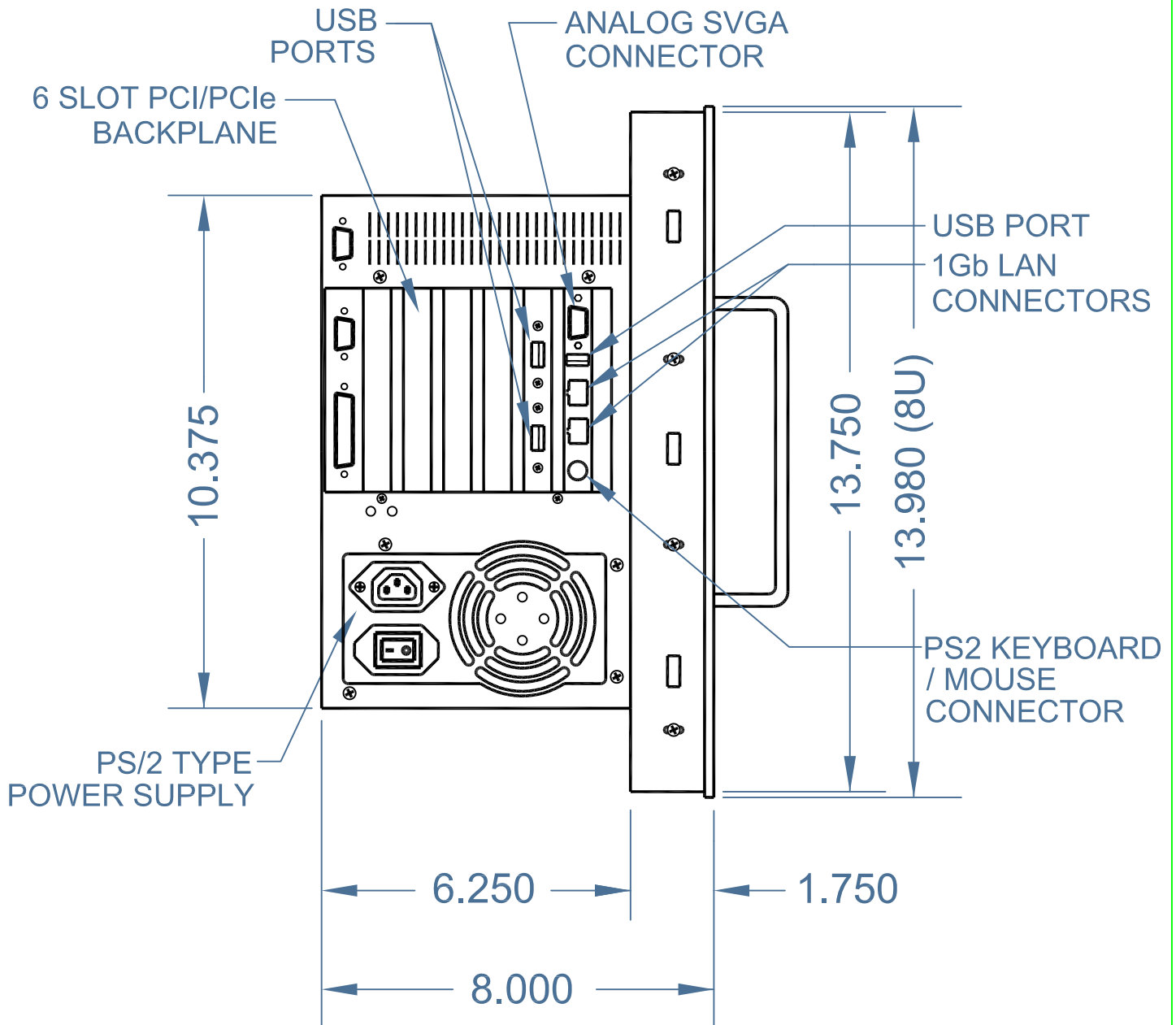

LEFT SIDE VIEW

DATE 06-25-2012	DRAWN BY B. G.	MODEL TR-7190-RM
PRODUCT PANEL PC-RACK MOUNT VERSION		REVISION
FINISH	<b>Transduction</b>	CHECKED BY NTS
TITLE <b>LAYOUT</b>		DRAWING No <b>B-531A</b>

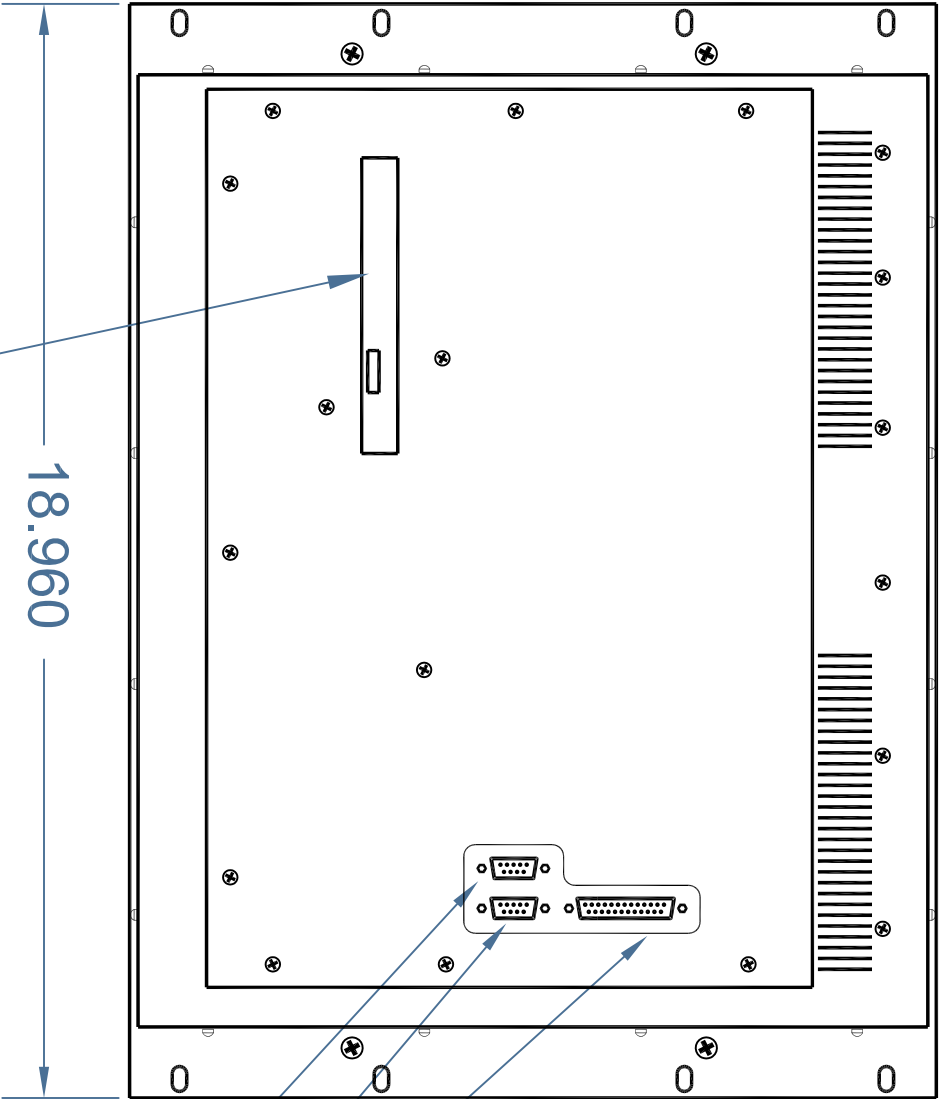

SLIM DVD/CD RW DRIVE

18.960

13.980 (8U)

LPT  
COM1  
COM2

REAR VIEW

DATE	06-25-2012	DRAWN BY	B.G.	MODEL	TR-7190-RM
PRODUCT	Transaction		REVISION	CHECKED BY	NTS
FINISH	Transaction		SCALE		
TITLE	LAYOUT		DRAWING No	B-532	

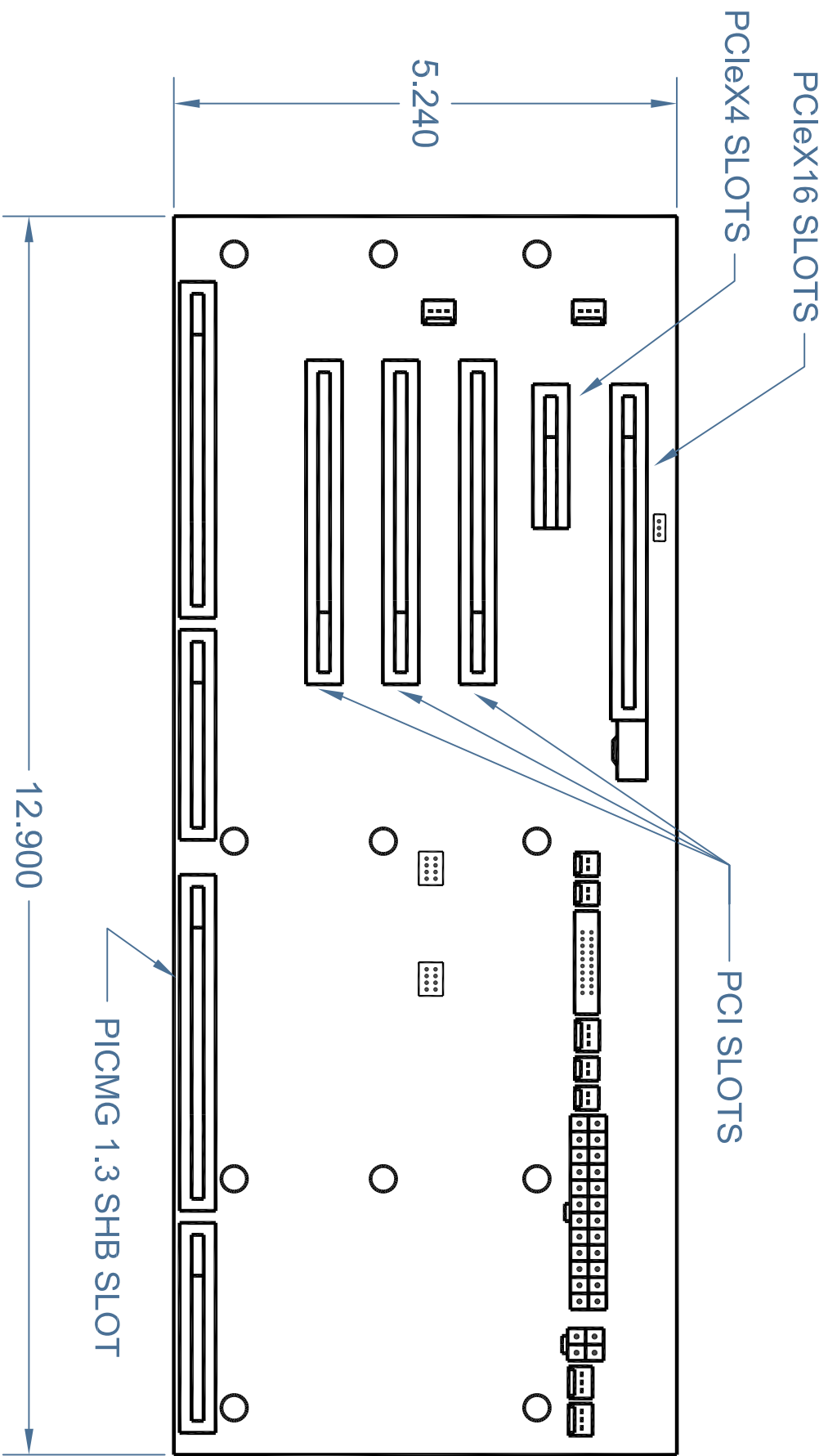

NOTE: ALL DIMENSIONS IN INCHES

DATE	06-25-2012	DRAWN BY	B.G.	MODEL	PCI/PCIe BACKPLANE
PART NO.	TR-6S2	REVISION		SCALE	NTS
FINISH	Transduction	CHECKED BY			
TITLE	LAYOUT	DRAWING NO.	B-533		

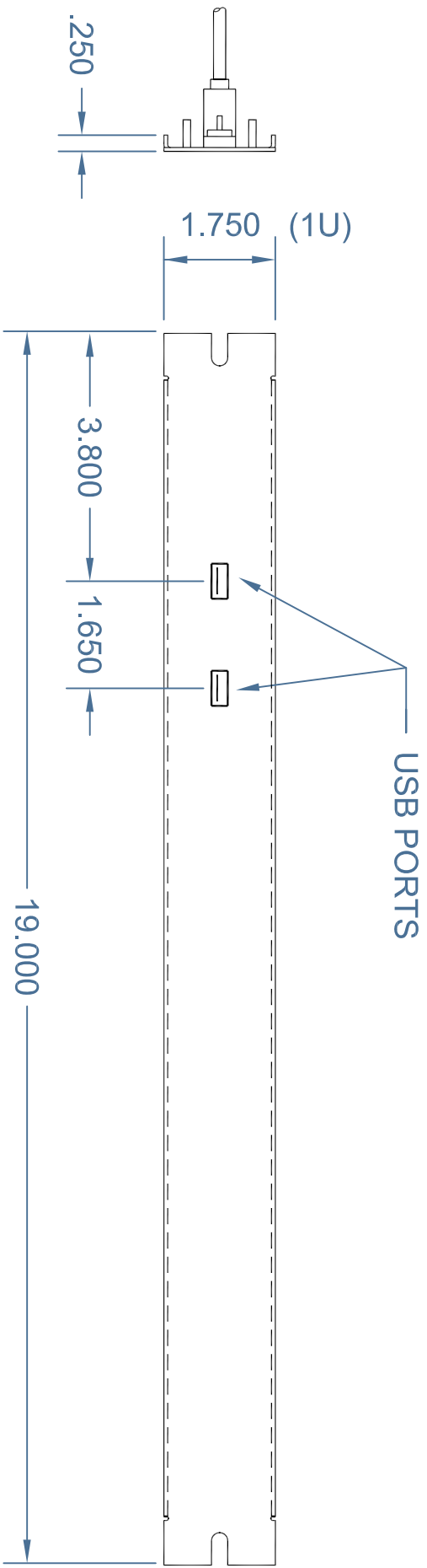

SIDE VIEW

FRONT VIEW

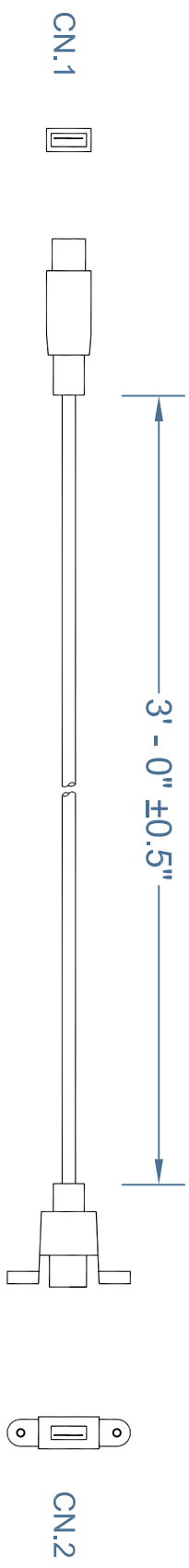

TWO USB CABLES  
MOUNTED ON THE PLATE

DATE	02-01-2010	DRAWN BY	B.G.	MODEL	1U USB FILLER
FINISH	SANDTEX BLACK PAINT	REVISION		CHECKED BY	NTS
TITLE	TR-RM-USB PLATE				SCALE
	LAYOUT		DRAWING NO		B-436A

STUD #6-32 x .500 4 PLACES FOR PANEL MOUNTING

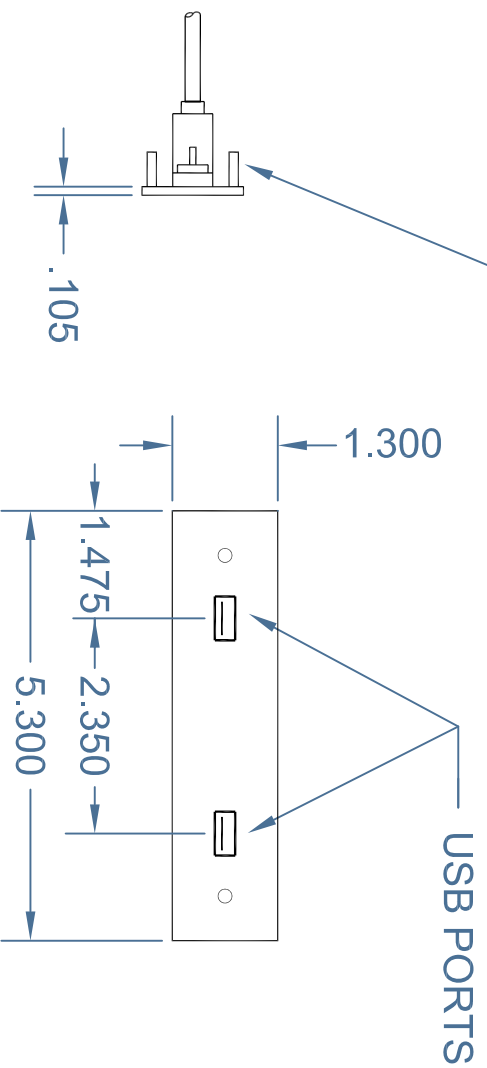

USB PORTS

Ø.166 4 PLACES

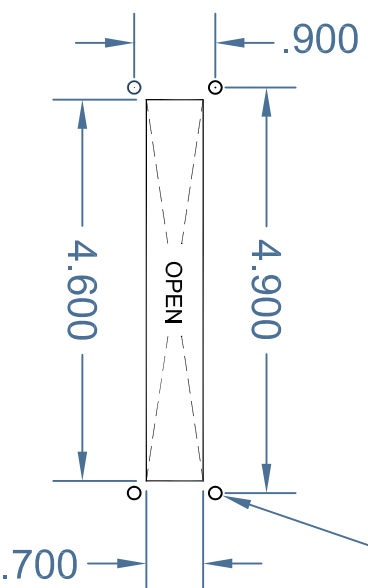

SIDE VIEW

FRONT VIEW

PANEL CUTOUT

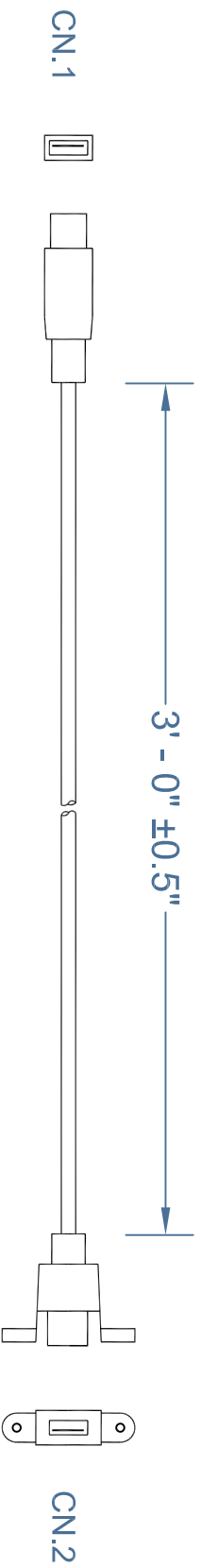

TWO USB CABLES

MOUNTED ON THE PLATE

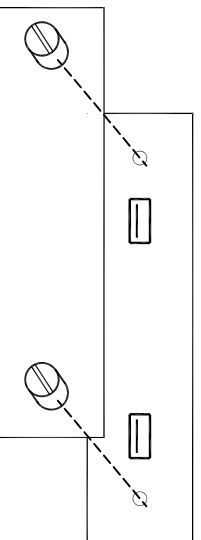

COVER PLATE

DATE	02-01-2010	DRAWN BY	B.G.	MODEL	FILLER PLATE
FINISH	SANDTEX BLACK PAINT	CHECKED BY	Transduction	REVISION	SCALE
TITLE	LAYOUT			DRAWING NO.	B-476A
					NTS